

Installation and User's Guide



We value your feedback!

Your input helps to create even better products and experiences.

Share the warmth and leave a review.

[dimplex.com/sharethewarmth](https://www.dimplex.com/sharethewarmth)

 [YouTube/Dimplex](https://www.youtube.com/Dimplex) 



IMPORTANT SAFETY INFORMATION:

Read this manual first before attempting to install or use this electric fireplace. Always comply with the warnings and safety instructions contained in this manual to prevent personal injury or property damage.

To view the full line of Dimplex products, visit www.dimplex.com

Table of Contents

Welcome	3
⚠ IMPORTANT INSTRUCTIONS	4
Technical Specifications	6
Electrical Rating	6
Product Dimensions	6
Package Contents	7
Installation	9
Placement	9
Recessed Installation	10
Wall-mounted Installation	11
Electrical Installation	12
Heater Hardware Disconnect	13
Mirrored Glass Installation	14
Media Installation	14
Front Glass Installation	15
Operation	16
General Operation	16
Hidden Touch Controls	16
Remote Operation	16
App	16
Resetting the Temperature Cutoff Switch	18
Maintenance	19
Troubleshooting	20
Wiring Diagrams	21
Warranty	23

Conventions used in this manual:

! **NOTE:** Procedures and techniques considered important enough to emphasize.

⚠ **CAUTION:** Procedures and techniques which, if not carefully followed, will result in damage to the equipment.

⚠ **WARNING:** Procedures, precautions and techniques which, if not carefully followed, will expose the user to the risk of fire, serious injury, or death.

Welcome

Thank you and congratulations for choosing to purchase a Dimplex fireplace.

Please carefully read and save these instructions.

⚠ CAUTION: Read all instructions and warnings carefully before starting installation. Failure to follow these instructions may result in a possible electric shock, fire hazard and will void the warranty.

Please record your model and serial numbers for future reference. Model and serial numbers can be found on the label located on the label behind the front glass of your fireplace and on the back of the Installation and User's Guide provided with your fireplace.

Model _____ MOD _____

Serial Number _____

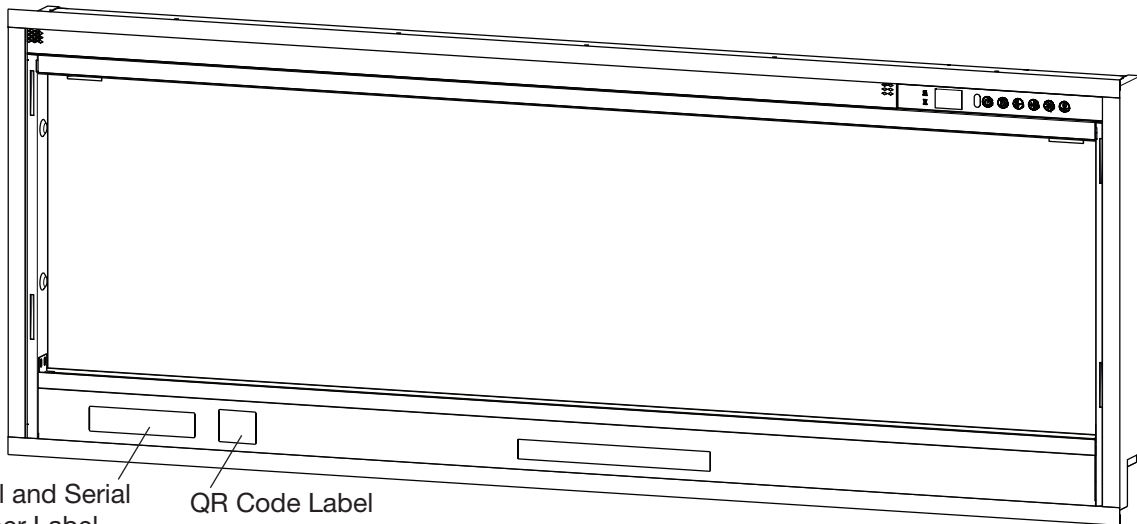

Model and Serial
Number Label
(behind front glass)

QR Code Label
(behind front glass)

Visit www.dimplex.com/fcapp

STOP NO NEED TO RETURN TO THE STORE

If you have questions regarding the operation of this product or if you require service, before returning this product to place of purchase,

Contact us at:  www.dimplex.com/customer_support

For Troubleshooting and Technical Support

OR  Toll-Free 1-888-346-7539

Please have your model number and product serial number ready.

IMPORTANT INSTRUCTIONS

When using any electrical appliance, basic precautions should always be followed to reduce the risk of fire, electric shock, and injury to persons. These precautions include:

① Read all instructions before using this electric fireplace.

 **DANGER:** High temperatures may be generated under certain abnormal conditions. Do not partially or fully cover or obstruct the front of the fireplace.

② This fireplace is hot when in use. To avoid burns, do not let bare skin touch hot surfaces. The trim around the heater outlet becomes hot during heater operation. Keep combustible materials, such as furniture, pillows, bedding, papers, clothes, and curtains at least 3 feet (0.9 m) from the front of the fireplace.

③ Extreme caution is necessary when the fireplace is used by or near children or people with disabilities and whenever the fireplace is left operating and unattended.

④ Always turn off the fireplace when it is not in use.

⑤ Do not operate the fireplace after it malfunctions, has been dropped, or damaged in any manner. Disconnect power at the service panel and have the fireplace inspected by a reputable electrician before using.

⑥ Do not use this fireplace outdoors.

⑦ Never locate the fireplace where it may fall into a bathtub or other water container.

⑧ Do not insert or allow foreign objects to enter any ventilation or exhaust opening as this may cause an electric shock, fire, or damage to the fireplace.

⑨ To prevent a possible fire, do not block air intakes or exhaust in any manner.

⑩ To disconnect the heater, turn the unit off with the controls and turn off the power to the heater circuit at the main disconnect panel.

⑪ All electrical heaters have hot and arcing or sparking parts inside. Do not use it in areas where gasoline, paint, or flammable liquids are used or stored.

⑫ Do not modify this fireplace. Use it only as described in this manual. Any other use may cause fire, electric shock, or injury to persons.

⑬ Do not burn wood or other materials in this fireplace.

⑭ Disconnect all power coming to the fireplace at the main service panel before performing any cleaning or maintenance.

⑮ When transporting or storing the fireplace, keep it in a dry place, free from excessive vibration, and store to avoid damage.

⑯ Always use ground fault protection where required by electrical code.

⑰ Changes or modifications not expressly approved by the party responsible for compliance could void user's authority to operate the equipment.

SAVE THESE INSTRUCTIONS



CAUTION
RISK OF ELECTRIC SHOCK
DO NOT OPEN
NO USER-SERVICEABLE PARTS INSIDE



IMPORTANT INSTRUCTIONS

FCC Compliance

⚠ CAUTION: This unit has been tested and found to comply with the limits for Class B digital device, pursuant to part 15 of the FCC Rules. These limits are designed to provide reasonable protection against harmful interference in a residential installation. This unit generates, uses and can radiate radio frequency energy and, if not installed and used in accordance with the instructions, may cause harmful interference to radio or television reception, which can be determined by turning the unit OFF and ON, the user is encouraged to try to correct the interference by one or more of the following measures:

Reorient or relocate the receiving antenna.

Increase the separation between the unit and the receiver.

Connect the unit into an outlet on a circuit different from that to which the receiver is connected.

Consult the dealer or an experienced radio/TV technician for help.

This unit complies with Part 15 of the FCC Rules. Operation is subject to the following two conditions: (1) This unit may not cause harmful interference, and (2) this unit must accept any interference received, including interference that may cause undesired operation.

⚠ FCC CAUTION: Any changes or modifications not expressly approved by the party responsible for compliance could void the user's authority to operate this equipment.

⚠ WARNING: This product can expose you to chemicals including nickel which is known to the State of California to cause cancer. For more information, visit www.P65Warnings.ca.gov

Technical Specifications

Electrical Rating

Voltage: 120 V

Power: 1500 W

UL Listing

File Number: E71416



Model Reference	
PLF3614-XS	6910470100
PLF4214-XS	6910470200
PLF5014-XS	6910470300
PLF6014-XS	6910470400



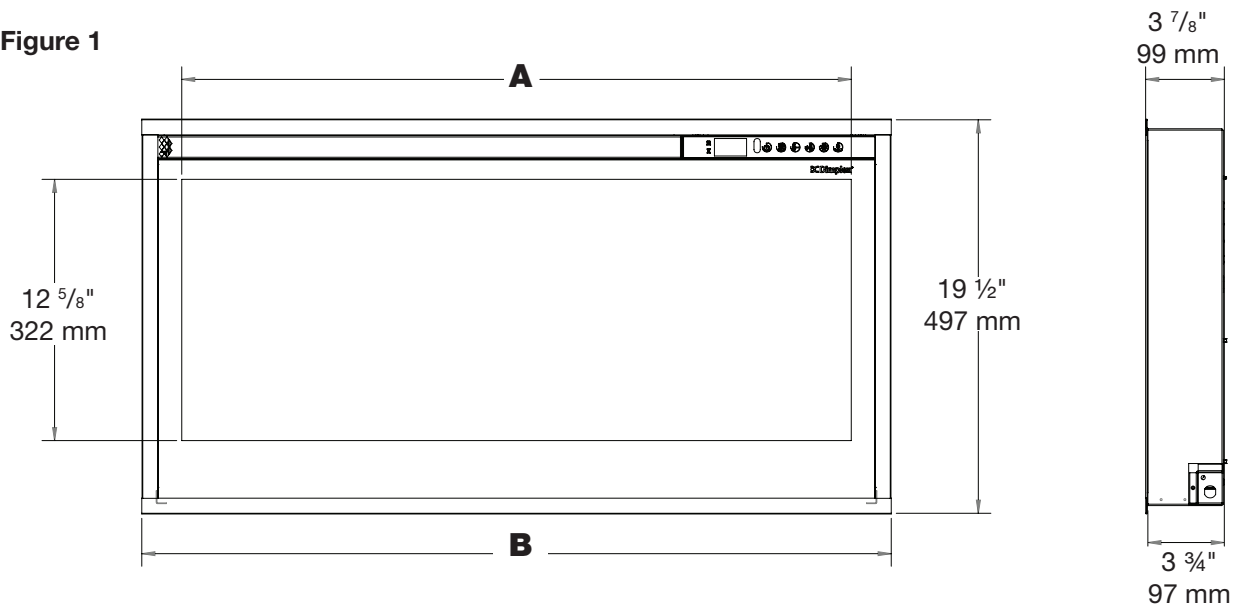

Product Dimensions

Figure 1



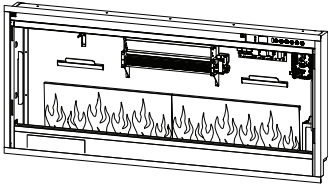
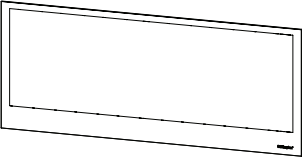
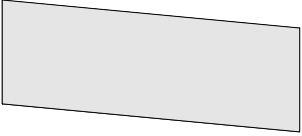



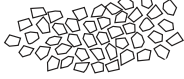
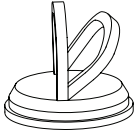

Model	A		B	
	in	mm	in	mm
PLF3614-XS	33 1/4"	845 mm	37 1/4"	946 mm
PLF4214-XS	39 1/4"	997 mm	43 1/4"	1098 mm
PLF5014-XS	47 1/4"	1201 mm	51 1/4"	1301 mm
PLF6014-XS	57 1/4"	1455 mm	61 1/4"	1555 mm

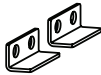
Package Contents

Image	Description	Quantity			
		PLF3614-XS	PLF4214-XS	PLF5014-XS	PLF6014-XS
	Firebox	1	1	1	1
	Front Glass	1	1	1	1
	Mirrored Glass	1	1	1	1
	Wall-mount Bracket	1	1	1	1
	Media Bed	1	1	1	1
	Remote Control	1	1	1	1
	Installation and User's Guide	1	1	1	1
	Bag of Acrylic Crystals	1	1	2	2
 Do not dispose of the suction cup after installation. Keep it in a secure location as it will be helpful for maintenance and service of the unit.	Suction Cup	1	1	1	1

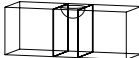
Package Contents

Hardware Kit					
	Media Bed Brackets	2	2	2	2
	Mirrored Glass Bracket	1	1	2	2
	1" Wood Screws	5	5	5	5
	Black Screws	7	7	10	10
	Bubble Level	1	1	1	1
	Wire Connector	3	3	3	3

! NOTE: When unpacking the firebox, there may be a gap between the top beam and the mirrored glass trim. This is not a defect and it will correct itself once the mirrored glass is installed.

Installation

Placement

This fireplace can be fully recessed into a wall with 2x4 framing or mounted on the wall.

! NOTE: It is recommended that the bottom of the unit be mounted between 20" (51 cm) and 40" (102 cm) from the ground to maintain an optimized viewing angle of the flame.

⚠ WARNING: The top of the fireplace must be installed a minimum of 24" (61 cm) from the ceiling.
The fireplace must be installed a minimum of 5" (13 cm) from the ground

Installation in a Bathroom

If this unit is installed in a bathroom it must be protected by a GFCI receptacle or circuit. If a receptacle is used it must be readily accessible.

This electrical appliance is NOT watertight. To prevent electric shock, it must be installed as to prevent water from entering the unit, or installed away from showers, tubs, etc. Never locate fireplace where it may fall into a bathtub or other water container.

Wi-Fi

For installations where the use of the Flame Connect app is desired, ensure the fireplace is located within range of a Wi-Fi network. For up to date information about the app, please visit www.dimplex.com/fcapp

Installation Recommendations for Overhanging Objects

For overhanging temperature-sensitive objects, such as a television, a mantel, or artwork, always follow the recommendations provided by its manufacturer for installation over a heater.

! NOTE: Using normal heat mode, surfaces 7" (18 cm) above the fireplace will not exceed 40° C, as long as installation procedures are followed and heater inlet and outlet are not obstructed.

Recessed Installation

1. Remove the side cover panels from the fireplace by removing the 5 screws on each of the cover panels (4 on the back of the fireplace, 1 on the bottom). (Figure 2)
 2. If a trimless installation is desired, remove pre-installed trim by removing the screws (number of screws will vary by model). (Figure 3)
- ! NOTE:** The pre-installed trim helps conceal imperfections in the drywall edges against the fireplace and gives the fireplace a finished appearance.
3. Prepare a framed opening, following the dimensions in the table below. (Figure 4)

Framing Dimensions

Model	Width	Height	Depth* (minimum)
	A	B	C
PLF3614-XS	37" 940 mm	19 1/8" 486 mm	4" 102 mm * Includes 1/2" drywall
PLF4214-XS	43" 1092 mm		
PLF5014-XS	51" 1295 mm		
PLF6014-XS	61" 1549 mm		

! CAUTION: This fireplace is **NOT** load-bearing. Ensure the opening for the fireplace is framed in such a way that the weight of the building materials will not create pressure on the top of the fireplace.

! NOTE: Wiring is performed at the bottom right back corner of the firebox. (Figure 5) Plan the framing to allow routing the power cable to this location.

4. Install and finish drywall as desired.
5. Remove the 3 screws that secure the electrical cover to complete the wiring. (Figure 5)
6. Complete the wiring according to instructions in the *Electrical Installation* section (pp. 12-13). Reinstall the electrical cover after wiring is complete.
7. Lift the firebox into the opening in the framing.
8. Level the firebox. A bubble level is included in the hardware kit provided.

Figure 2

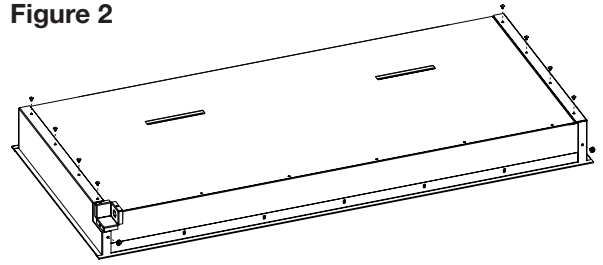

Figure 3

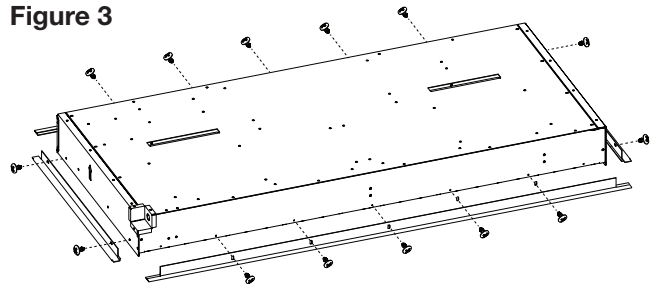

Figure 4

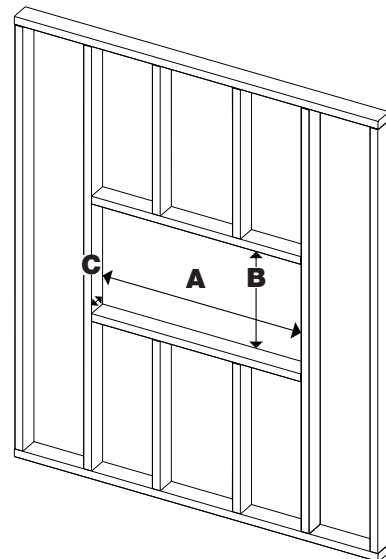
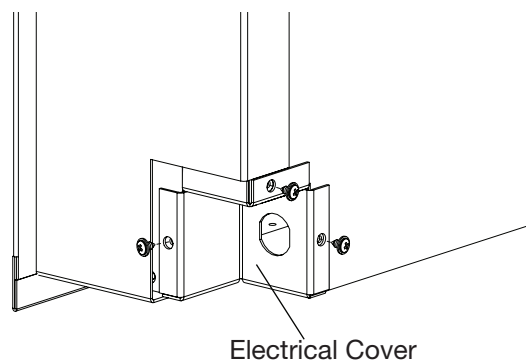

Figure 5



Installation

9. Drive 4 screws through the mounting holes located on the inside sides of the firebox into the surrounding frame. (Figure 6)

⚠ CAUTION: Ensure the air intake and heater exhaust are not obstructed in installation. These are located behind the front grill.

10. Follow the instructions for installing the mirrored glass, media bed, and front glass (pp. 14-15).

Figure 6

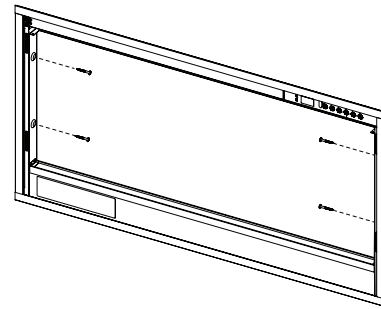

Wall-mounted Installation

1. If using the optional power cord accessory (PLFXSPLUG, sold separately), install it following the instructions in the wiring section (p.13).
2. Remove the 3 screws that secure the electrical cover to complete the wiring. (Figure 5)
3. Complete the wiring according to instructions in the *Electrical Installation* section (pp. 12-13). Reinstall the electrical cover after wiring is complete.
4. Position mounting bracket in desired location on the wall and ensure that it is level using the provided bubble level.
5. Use 2 of the provided mounting screws to attach the mounting bracket onto wall. The mounting screws must be inserted into wall studs.
6. Lift the fireplace onto the mounting bracket. (Figure 8) The flanges from the mounting bracket should be inserted into the slots on the back of the fireplace. (Figure 9)
7. Follow the instructions for installing the mirrored glass, media bed, and front glass (pp. 14-15).

Figure 7

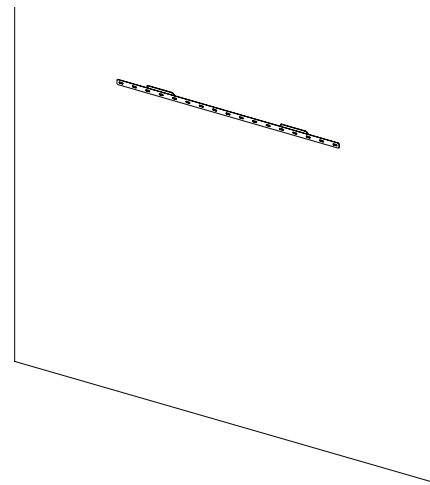

Figure 8

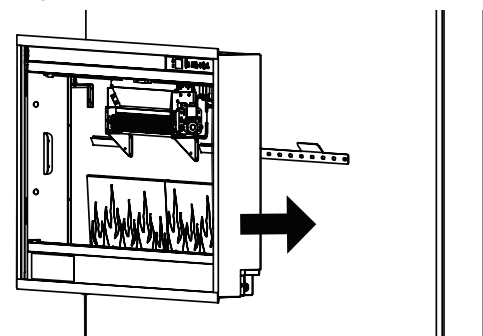
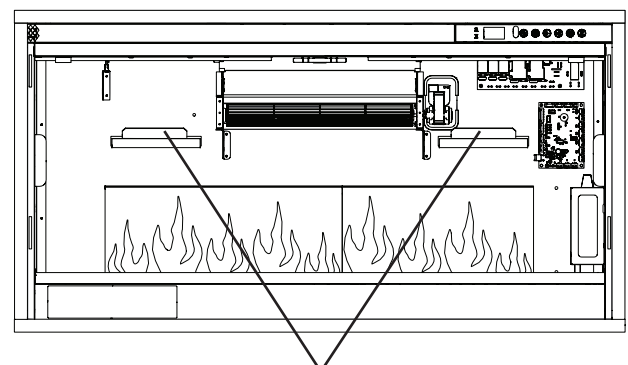

Figure 9



Wall bracket flanges inserted in slots

Electrical Installation

- ⚠ WARNING:** The installation of the electric fireplace must comply with the applicable Local and/or National Electrical Codes and utility requirements.
- ⚠ CAUTION:** A dedicated, properly fused 15 Amp circuit is recommended, rated for 120 V. A dedicated circuit will be required if, after installation, the circuit breaker trips or fuse blows on a regular basis when the heater is operating. Additional appliances on the same circuit may exceed the current rating of the circuit breaker.
- ! NOTE:** If required, the service cable can be secured through the electrical cover using a ½" (1.3 cm) approved strain relief connector.

120 V Hardwire Installation (Figure 10)

- ⚠ WARNING:** Use the appropriate wire to meet local and national electrical codes for rated power consumption.
1. Connect the black L wire from the unit to the live wire from the power supply with a wire connector.
 2. Connect the white N wire from the unit to the neutral wire from the power supply with a wire connector.
 3. Connect the green G wire from the unit to the ground wire from the power supply with a wire connector or attach the grounding wire to the cover with the provided grounding screw, by placing the wire between screw and lock washer and tighten.
 4. Ensure all wire connections are tight.

Figure 10

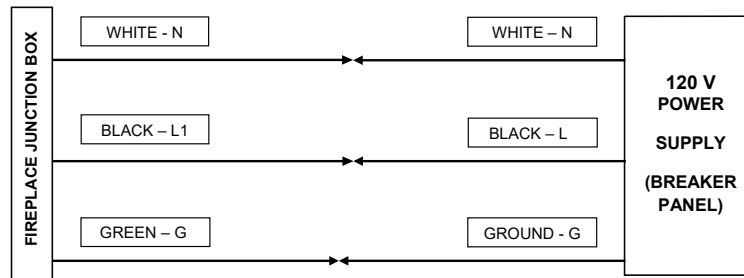

120V Installation - Wall Switch (Figure 11)

- ! NOTE:** Use a single pole, single throw (On/Off) wall switch that is rated for a minimum of 15 amps.
 - ⚠ WARNING:** Use the appropriate wire to meet local and national electrical codes for rated power consumption.
1. Connect the black L wire from the unit to the live wire from the main power through the wall switch, ensuring all live connections are connected with a wire connector.
 2. Connect the white N wire from the unit to the neutral wire from the power supply with a wire connector.
 3. Connect the green G wire from the unit to the ground wire from the power supply with a wire connector or attach the grounding wire to the cover with the provided grounding screw, by placing the wire between screw and lock washer and tighten.
 4. Ensure all wire connections are tight.

Figure 11

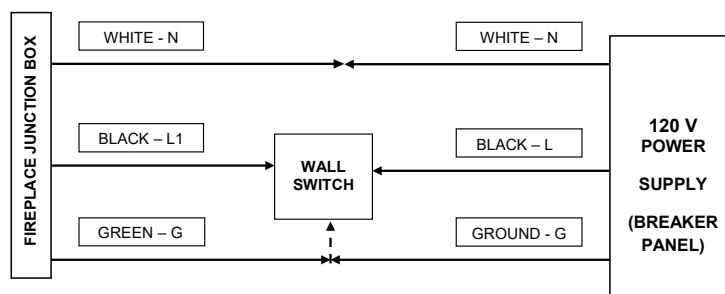

Installation

Optional Plug Kit (PLFXSPLUG, sold separately)

1. Remove the 3 screws that hold the electrical cover plate. (Figure 5, p.10)
2. Connect the black L wire from the unit to the black wire of the plug kit.
3. Connect the white N wire from the fireplace to the white wire from the plug kit.
4. Connect green G wire from the fireplace to the green wire from the plug kit.
5. Ensure all wire connections are tight.
6. Secure the power cord's pre-installed cover plate using the screws removed when removing the electrical cover plate. The previously removed electrical cover plate can be disposed of.

⚠ WARNING: This heater is not intended for use with an extension cord. Plug the cord directly into an appropriate wall receptacle.

Heater Hardware Disconnect

The fireplace heater can be permanently disabled by removing the electronic jumper on the main control board.

! NOTE: Heater hardware disconnect will permanently disable the heater and fan. Follow these instructions only when an installation without heat is required. Temporary disabling of the heater can be achieved through the hidden touch controls. See "Heat Disable" in *Operation* section (p. 17) for instructions.

To disconnect the heater and fan permanently:

1. Locate the main control board. The heater hardware disconnect jumper location is labeled "Heater Disable". (Figure 12).
2. Pull out the heater hardware disconnect jumper.

Figure 12

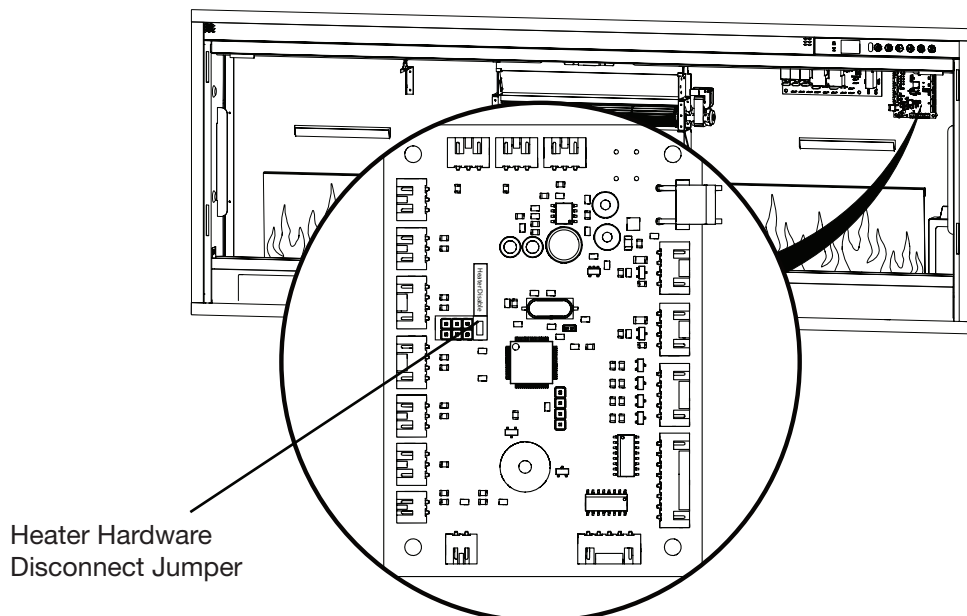

Installation

Mirrored Glass Installation

1. Attach the provided suction cup to the reflective side of the mirrored glass. Ensure the suction cup is securely attached.
2. Using the suction cup to assist, lift the mirrored glass and place it into the bottom crevice at an angle.
3. Tilt the glass up into position. The mirror will remain at a slight angle by design. (Figure 13)
4. Secure the mirror using the mirror retaining brackets and screws provided. (Figure 14)

⚠ CAUTION: Ensure the mirrored glass does not fall forward while the mirrored glass mounting brackets are being installed.

5. Remove the suction cup and clean any fingerprints or debris off the glass with a non-abrasive glass cleaner.

! NOTE: Do not dispose of the suction cup! Keep it in a secure location, as it may be needed for maintenance and service on this fireplace.

Figure 13

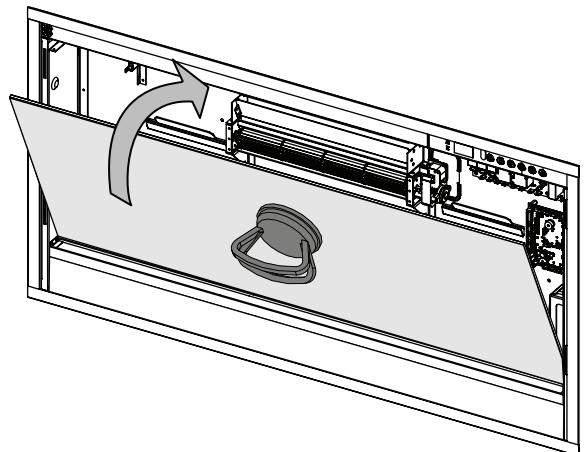
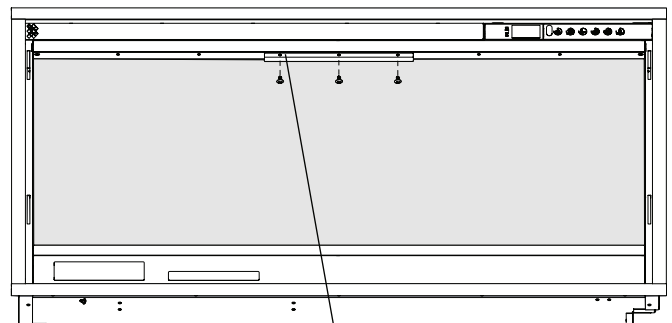

Figure 14



Mirrored Glass Bracket
(Quantity varies by model)

Figure 15

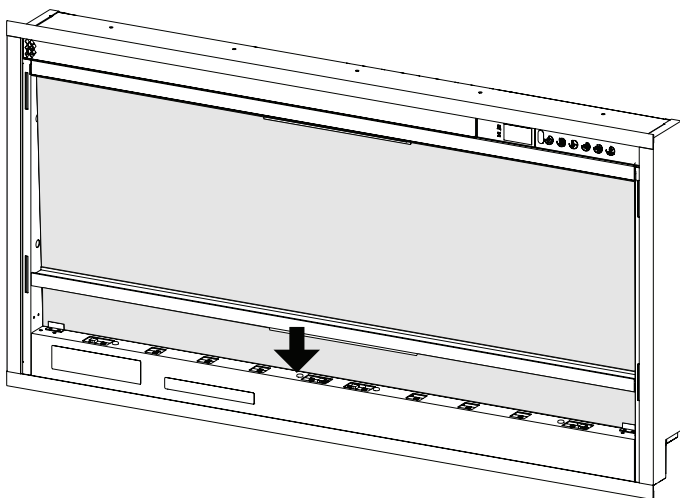
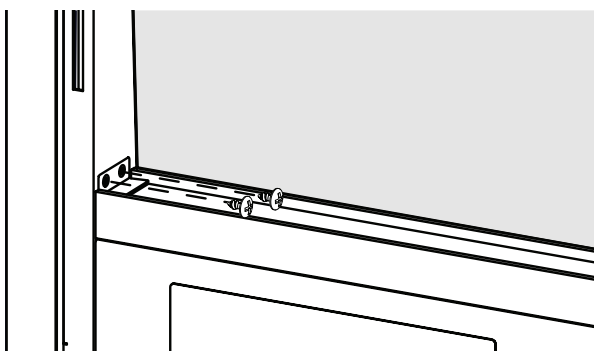

Figure 16



Media Installation

1. Position the media bed and secure it using the provided brackets and screws. (Figure 15)
2. Disperse the provided acrylic crystals evenly across the media bed.

It is possible to use custom media ornaments to decorate your firebox. The custom media must fit easily without scratching the glass or bowing the media bed, and must not be composed of sand or liquid, which could interfere with the safety of the firebox.

Installation

Front Glass Installation

1. Ensure there are no debris or finger prints on the mirrored glass or on the back of the front glass before you begin.
 2. Secure the provided suction cup on the front glass, ensuring it cannot be pulled off.
 3. Lift the glass using the suction cup, and align the 4 mounting brackets on the front glass with the corresponding slots on the fireplace.
 4. Insert the mounting brackets into the slots and gently release the glass so that it may drop into its final position.
 5. Remove the suction cup and clean any fingerprints or debris off the front glass with a nonabrasive glass cleaner.
- ! NOTE:** Do not dispose of the suction cup! Keep it in a secure location, as it may be needed for maintenance and service on this fireplace.

Figure 17

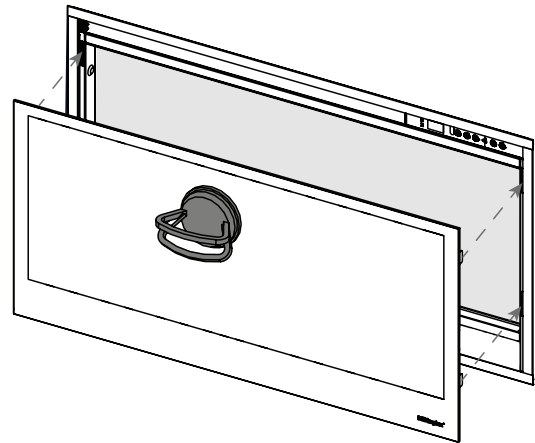

General Operation

⚠ WARNING : This electric firebox must be properly installed before it is used.

! NOTE: The element retains heat after shutdown. When the heat is turned Off, there is a 5-minute cool down period before the fan shuts off completely.

! NOTE: The fireplace will retain the previously used settings after a power interruption.

Hidden Touch Controls

The hidden touch controls are located on the upper right of the fireplace. (Figure 18)

Remote Operation

The fireplace is supplied with a multi-function IR remote control. (Figure 19)

! NOTE: To operate correctly, the remote control must be pointed towards the front of the unit.

App

The fireplace is capable of being controlled using the Flame Connect app for mobile devices. For up to date information about the app, please visit www.dimplex.com/fcapp

Figure 18

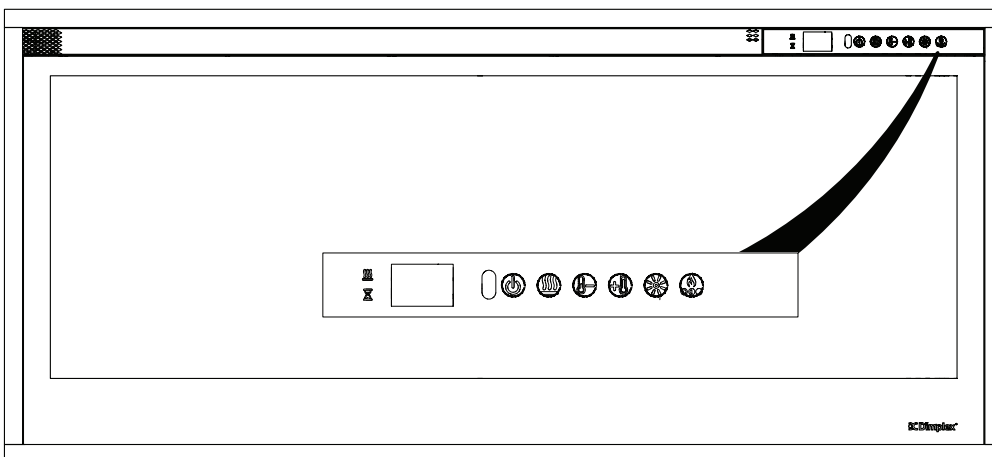



Figure 19



Standby

Press  to turn on the unit or to put it in Standby mode.

When the unit is turned back on, it will retain the previously used settings.



Flame Effect

Press  to turn the flame effect on or off.

































Flame Color

Press  repeatedly to cycle through the 7 different flame themes:

- 1 - Base with orange and blue accents
- 2 - Base with orange accents
- 3 - Base with blue accents
- 4 - Blue
- 5 - Orange
- 6 - Base
- 7 - Orange and blue

Operation

	Flame Speed	Press  repeatedly to cycle through the 5 flame speeds.
	Heat	Press  to turn the heat on or off. The fireplace will beep once and the  icon will remain on the display when activated. The fireplace can be operated in heat only mode by turning off the flame and color effects.
	Heat Disable	Press and hold the  and the  at the same time for 3 seconds to disable or enable the heat function. This action must be performed on the hidden touch controls . When the heat is disabled and either the  ,  , or  is pressed, --- will appear on the display.
	Temperature Increase	Press  to decrease the temperature setting.
	Temperature Decrease	Press  to increase the temperature setting.
		The temperature can be set from 7 °C to 30 °C (45 °F to 86 °F). When the temperature setting is adjusted, the set temperature will flash for 2 seconds, then the ambient room temperature will be displayed briefly.
	Temperature Display (°C ↔ °F)	Press and hold the  and the  at the same time for 3 seconds. This action must be performed on the hidden touch controls .
	Brightness	Press  repeatedly to cycle through the brightness and flicker modes. Solid L - Low Brightness Solid H - High Brightness Cycle L - Low Brightness with flickering media bed lights Cycle H - High Brightness with flickering media bed lights
	Ambient Light Sensor	Press  to turn the ambient light sensor on or off. The ambient light sensor will automatically adjust the brightness of the fireplace lights based on the ambient light in the room.
	Timer	Press  repeatedly until the desired number of hours of the timer is displayed. When this function is active, the fireplace will turn off after a set amount of time. The timer can be set from 30 minutes (display will show .5) to 8 hours in intervals of 30 minutes. To turn the timer off, press  repeatedly until  appears on the display. While the timer is active, press the timer button to see the time remaining.
	Moods	Press  repeatedly to cycle through the 8 different Moods, which will change the colour of the media bed lighting. 1 - White 2 - Blue 3 - Violet 4 - Red 5 - Green 6 - Prism — media cycles through colors 7 - Prism — media cycles through colors at a faster speed 8 - Midnight mode — media bed lighting is off
	Custom Color	Freeze the media bed lights to a custom color. When in one of the Prism modes (see Moods), press  while the desired color is displayed to freeze the cycle on that color. Press  again to resume the color cycle.

Factory Reset	Press and hold  and  at the same time for 3 seconds to reset all the settings to factory default. This action will also disconnect the unit from the Wi-F network if connected. This action must be performed on the hidden touch controls .
---------------	---

Resetting the Temperature Cutoff Switch

Should the heater overheat, a manual limit cut-out will turn the unit off and it will not come back on without being reset. If the  button on the unit is pressed, *Err 1* will be displayed on the unit. It can be reset by turning the unit off at the main disconnect panel and waiting 30 minutes before turning the unit back on.

⚠ CAUTION: If you need to continuously reset the heater, turn the unit off at the main disconnect panel and call technical support at: 1-888-346-7539.

Maintenance

Remote Control Battery Replacement

1. Remove the screw on the battery cover using a Philips screwdriver.
2. Depress tab and pull out to release battery compartment on bottom of the remote control.
3. Correctly install one 3 Volt (CR2032 [longer life] or CR2025) battery in the battery compartment
4. Insert the battery compartment and secure with the screw.



Battery must be recycled or disposed of properly. Check with your Local Authority or Retailer for recycling advice in your area

Figure 20

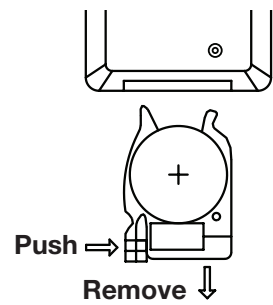

⚠WARNING: Disconnect power and allow heater to cool before attempting any maintenance or cleaning to reduce the risk of fire, electric shock or damage to persons.

Mirrored Glass Cleaning

The mirrored glass is cleaned in the factory during the assembly operation. During shipment, installation, handling, etc., the mirrored glass may collect dust particles; these can be removed by dusting lightly with a clean dry cloth.

To remove fingerprints or other marks, the mirrored glass can be cleaned with a damp cloth. The mirrored glass should be completely dried with a lint free cloth to prevent water spots. To prevent scratching, do not use abrasive cleaners.

Fireplace Surface Cleaning



Use only a damp cloth to clean painted surfaces of the fireplace. Do not use abrasive cleaners.

The fireplace should not be operated with an accumulation of dust or dirt on or in the unit, as this can cause a build up of heat and eventual damage. For this reason the heater must be inspected regularly, depending upon conditions and at a minimum yearly intervals.

Servicing

Except for installation and cleaning described in this manual, an authorized service representative should perform any other servicing.

Troubleshooting

Problem	Display	Cause	Solution
Fireplace does not turn on with the manual touch controls	N/A	No incoming power	Ensure unit is wired correctly Check main disconnect panel Ensure wall switch is on (if applicable)
Fireplace does not turn on with the remote control	N/A	The batteries in the remote control are dead or installed incorrectly	Replace remote control battery Ensure battery is installed with + facing up.
Heater does not turn on	---	Heater is disabled	Press and hold  and  at the same time on the hidden touch controls for 3 seconds to disable or enable the heat function.
	H--	Heater has been permanently disabled	If installation with heat is desired, re-install shunt on main board if available or purchase new main board.
Heater is on, but there is no heat		Normal operation — There is a 30-second delay before heater starts	No action required.
Circuit breaker trips or fuse blows when unit is turned on	N/A	Improper circuit current rating	Install unit on a dedicated minimum 15 amp circuit.
Error Code is displayed	Err 1	Temperature cutout is activated	Reset breaker and wait 30 minutes before turning unit back on it. If error persists, see Service Manual.
	Err 2	L1 voltage is too high	If error persists, consult an electrician.
	Err 3	L1 voltage is too low	If error persists, consult an electrician.
	Err 4	L1 current is too high	If error persists, consult an electrician.
	Err 7	Fan is slow	See service manual.
	Err 8	Element error	See service manual.
	Err 9	Element not detected	See service manual.
	Err 10	Fan not detected	See service manual.
	Err 11	Fan error	See service manual.
	Err 12	Ambient temperature is above 45° C (113° F)	No action required.
	Err 13	Ambient temperature is below 45° C (113° F)	No action required.
	Err 14	Thermistor error	See service manual.
	Err 15	NTC has shorted	See service manual.
	Err 16	NTC not detected	See service manual.
	Err 17	Media bed LEDs defective	See service manual.
	Err 18	Overhead LEDs defective	See service manual.
	Err 19	Media bed LEDs not detected	See service manual.
	Err 20	Overhead LEDs not detected	See service manual.
	Err 21	Flame LEDs not detected	See service manual.
	Err 22	Flicker motor not detected	See service manual.
	Err 23	Relay board not detected	See service manual.
	Err 24	Main control board not detected	See service manual.
	Err 25	Display board not detected	See service manual.

For more troubleshooting, consult the PLF-XS Service Manual which can be found at www.dimplex.com/customer_support/technical_and_troubleshooting

Wiring Diagrams

PLF3614-XS

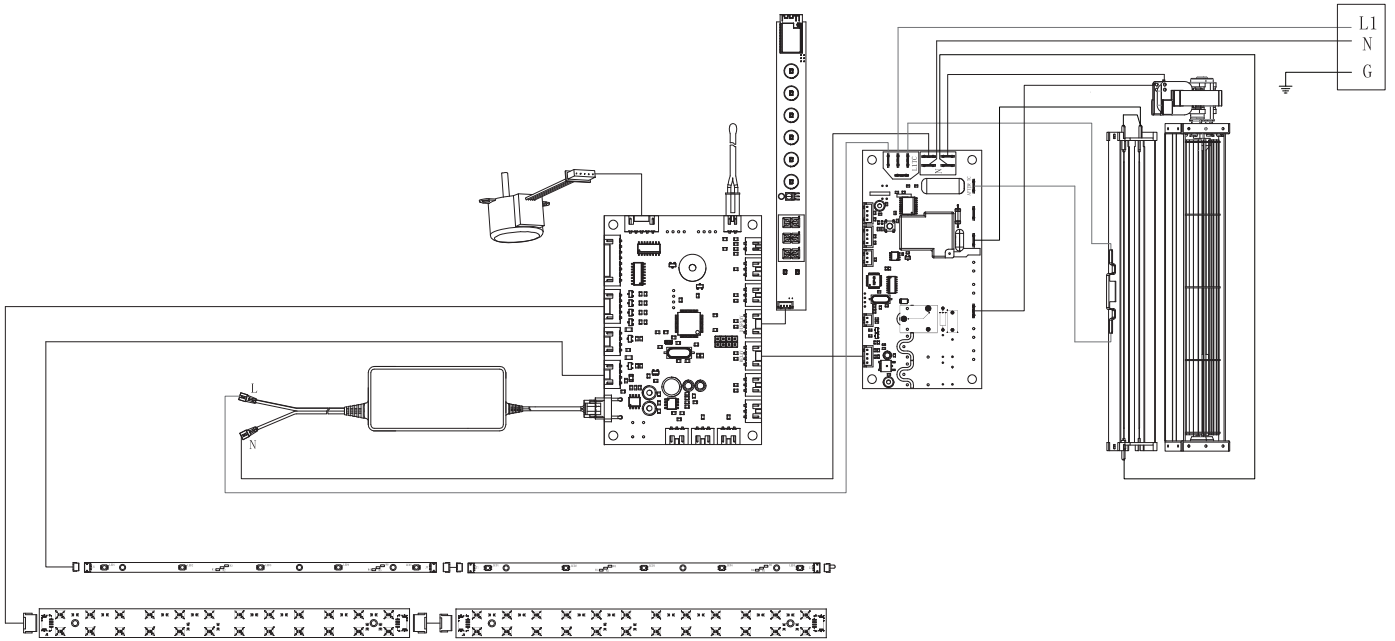

PLF4214-XS

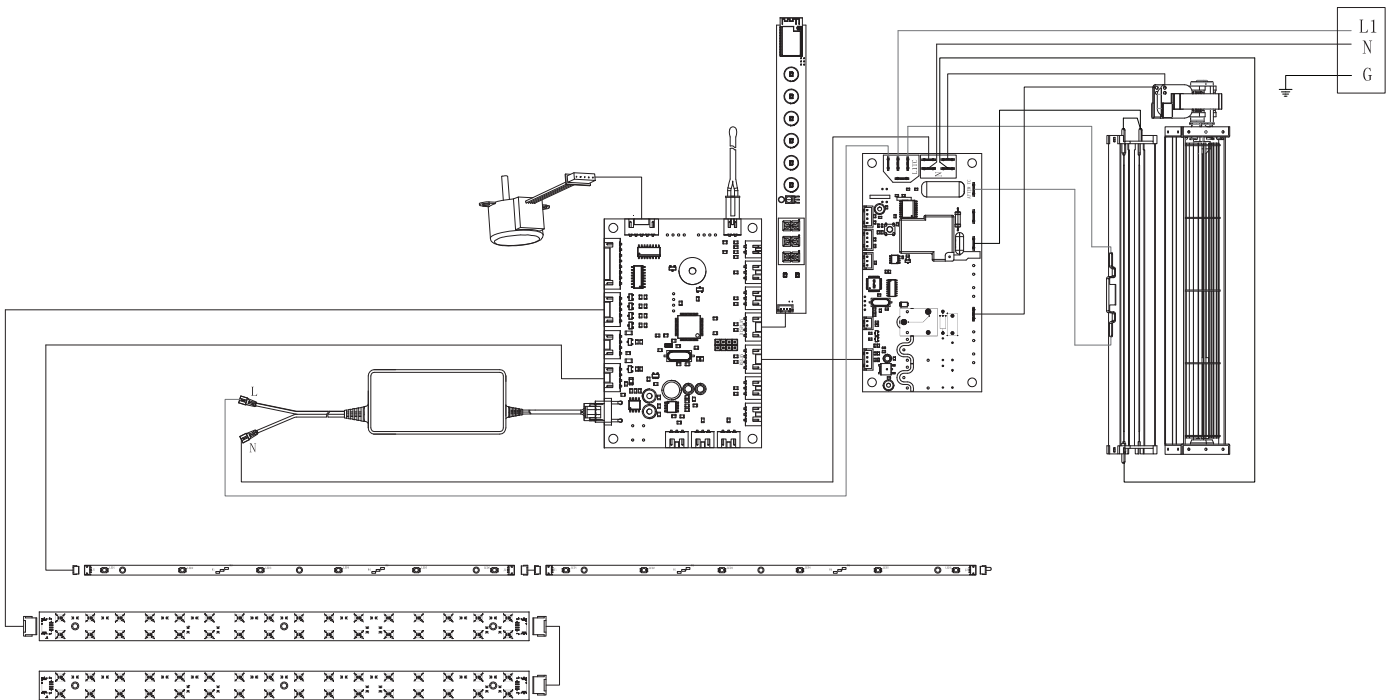

Wiring Diagrams

PLF5014-XS

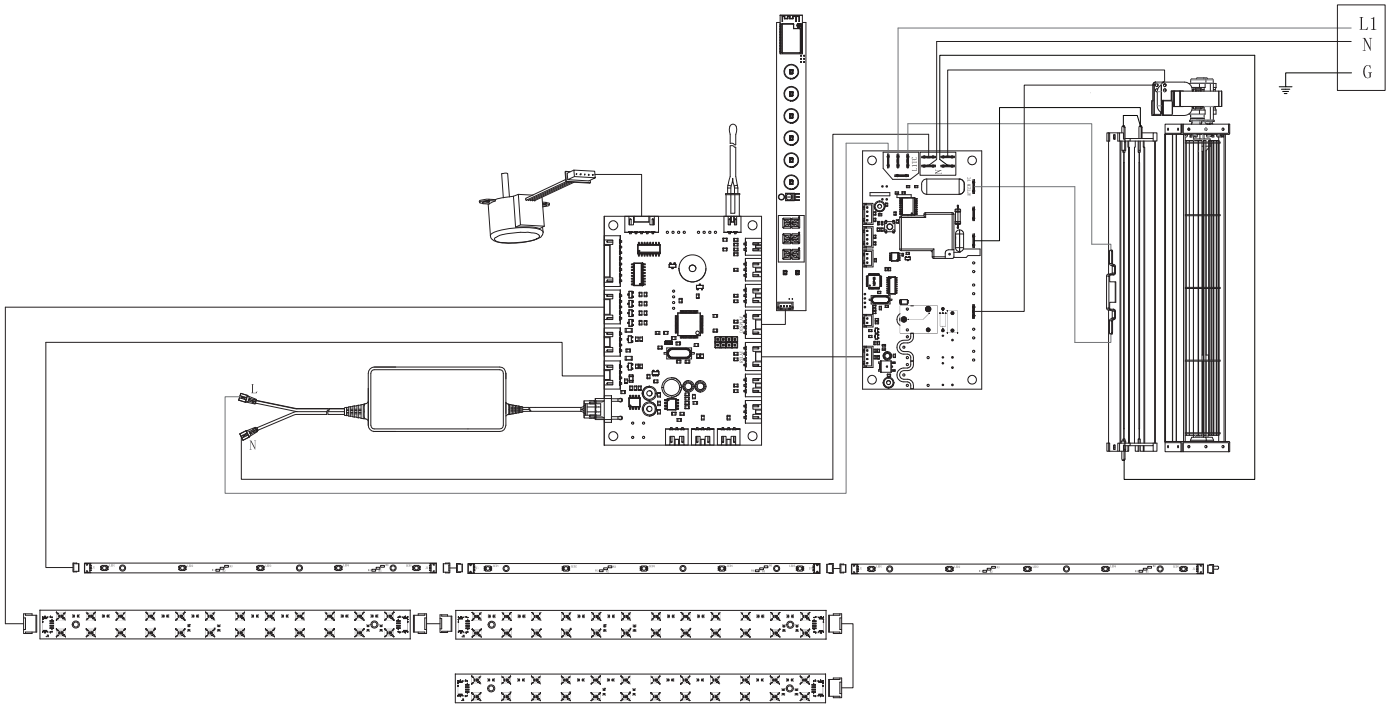

PLF6014-XS

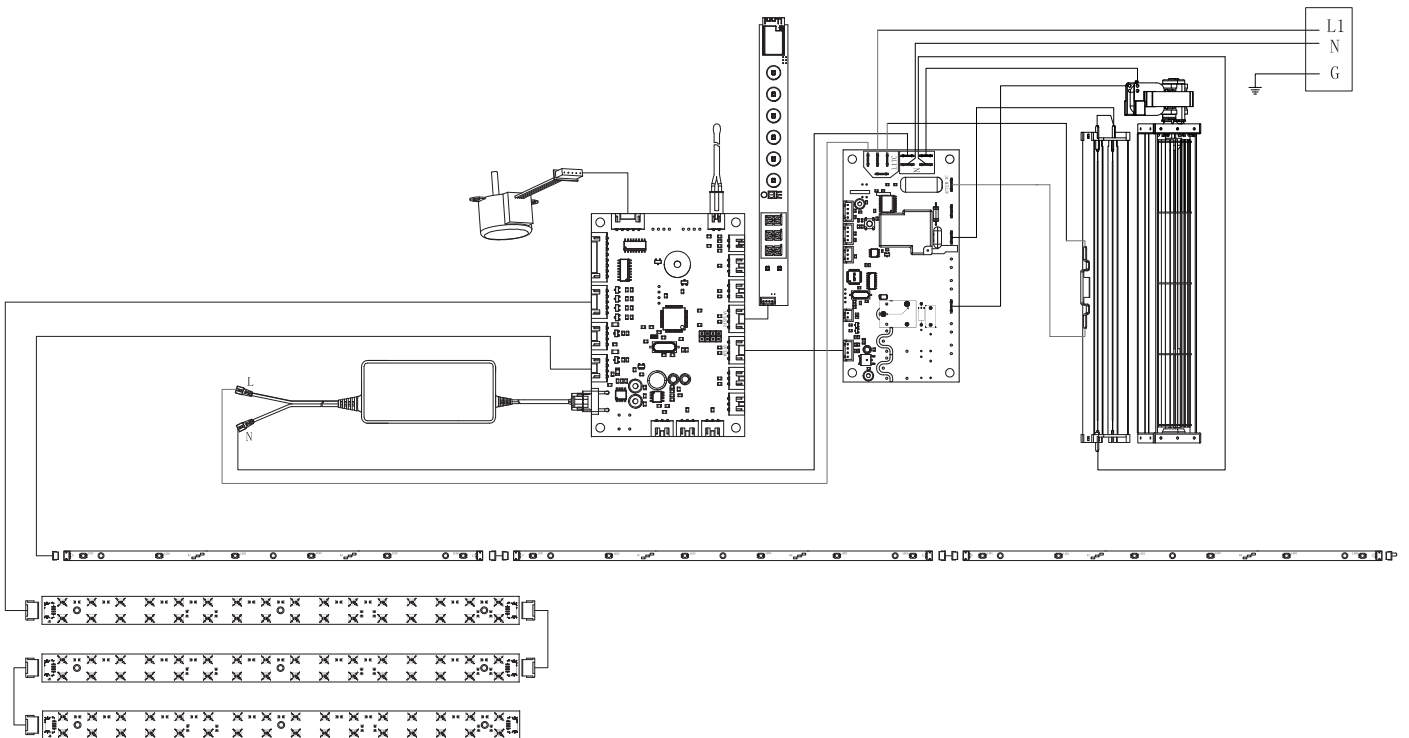

Warranty

MULTI-FIRE® SL 2 YEAR LIMITED WARRANTY

Section 1 Products to which this Limited Warranty Applies

This Limited Warranty applies to your newly purchased Dimplex Electric Fireplace with Model Numbers PLF3614-XS, PLF4214-XS, PLF5014-XS, and PLF6014-XS.

This Limited Warranty applies only to purchases made in any province of Canada except for Yukon Territory, Nunavut, or Northwest Territories or in any of the 50 States of the USA and the District of Columbia except for Hawaii and Alaska. This Limited Warranty applies to the original purchaser of the product only and is not transferable.

Section 2 Products excluded from this Limited Warranty

Products purchased in Yukon Territory, Nunavut, Northwest Territories, Hawaii, or Alaska are not covered by this Limited Warranty. Products purchased in these States, Provinces, or Territories are sold AS IS without Warranty or condition of any kind including, without limitation, any implied warranties or conditions of merchantability or fitness for a particular purpose. The entire risk of as to the quality and performance of the products is with the purchaser. In the event of a defect the purchaser assumes the entire cost of all necessary servicing or repair.

Section 3 What this Limited Warranty covers and for How Long

MULTI-FIRE® SL products PLF3614-XS, PLF4214-XS, PLF5014-XS, and PLF6014-XS excluding trims and accessory packages are covered by this Limited Warranty, have been tested and inspected prior to shipment and, subject to the provisions of this Warranty, Glen Dimplex Americas Ltd. (herein called Glen Dimplex Americas) warrants such products to be free from defects in material and workmanship for a period of 2 years from the date of the first purchase of such products. 2-year Limited Warranty entitles the purchaser to On-site or In-home Warranty Services. Accordingly, Glen Dimplex Americas will be responsible for all labor and transportation associated with repairing or replacing the product or part. Exceptions to this are outlined in Section 5. Some jurisdictions do not allow limitations on how long an implied Warranty lasts, so the above limitation may not apply to the purchaser.

Section 4 What this Limited Warranty Does Not Cover

This Limited Warranty does not apply to products that have been repaired (except by Glen Dimplex Americas or its authorized service representatives) or otherwise altered. This Limited Warranty does further not apply to defects resulting from misuse, abuse, accident, neglect, incorrect installation, improper maintenance or handling, or operation with an incorrect power source.

Section 5 How to notify us of a Warranty Concern

Defects must be brought to the attention of Dimplex Customer Service online at dimplex.com/en/contact_us or by telephone at 1-888-346-7539. Please have proof of purchase, catalogue/model and serial numbers available for representatives to assist. **Limited In-home Warranty Services require proof of purchase.

In the event a product or part covered by this Limited Warranty is proven to be defective in material or workmanship during (i) the 2-year Limited Warranty period for products outlined in Section 1, you have the following rights:

- Glen Dimplex Americas will in its sole discretion either repair or replace such defective product or part without charge. If Glen Dimplex Americas is unable to repair or replace such product or part, or if repair or replacement is not commercially practicable or cannot be timely made, Glen Dimplex Americas may, in lieu of repair or replacement, choose to refund the purchase price for such product or part.
- Limited Warranty service will be performed solely by dealers or service agents of Glen Dimplex Americas authorized to provide Limited Warranty services.
- This 2-year Limited Warranty entitles the purchaser to On-site or In-home Warranty services. Accordingly, Glen Dimplex Americas will be responsible for all labor and transportation associated with repairing or replacing the product or part except as follows: (i) charges which may be levied for travel costs incurred to travel to the purchaser's site where the product is located if the purchaser's site is beyond 30 miles (48 km) from the closest service depot of Glen Dimplex Americas dealer or service agent; and (ii) the purchaser is solely responsible for providing clear access to all serviceable parts of the product.
- Glen Dimplex Americas will not be responsible for, and this Limited Warranty shall not include, any expense incurred for installation or removal of the surrounds (mantels) or trims or any part thereof (or any replacement product or part) including, without limitation, all shipping costs and transportation costs to and from the authorized dealer's or service agent's place of business and all labor costs. Such costs shall be the purchaser's sole responsibility.

Section 6 When Glen Dimplex Americas and its Dealers and Service Agents are not Liable

IN NO EVENT WILL GLEN DIMPLEX AMERICAS, OR ITS DIRECTORS, OFFICERS, OR AGENTS, BE LIABLE TO THE PURCHASER OR ANY THIRD PARTY. WHETHER IN CONTRACT, IN TORT, OR ON ANY OTHER BASIS, FOR ANY INDIRECT, SPECIAL, PUNITIVE, EXEMPLARY, CONSEQUENTIAL, OR INCIDENTAL LOSS, COST, OR DAMAGE ARISING OUT OF OR IN CONNECTION WITH THE SALE, MAINTENANCE, USE, OR INABILITY TO USE THE PRODUCT, EVEN IF GLEN DIMPLEX AMERICAS OR ITS DIRECTORS, OFFICERS, OR AGENTS HAVE BEEN ADVISED OF THE POSSIBILITY OF SUCH LOSSES, COSTS OR DAMAGES, OR IF SUCH LOSSES, COSTS, OR DAMAGES ARE FORESEEABLE. IN NO EVENT WILL GLEN DIMPLEX AMERICAS, OR ITS OFFICERS, DIRECTORS, OR AGENTS BE LIABLE FOR ANY DIRECT LOSSES, COSTS, OR DAMAGES THAT EXCEED THE PURCHASE PRICE OF THE PRODUCT. SOME JURISDICTIONS DO NOT ALLOW THE EXCLUSION OR LIMITATION OF INCIDENTAL OR CONSEQUENTIAL DAMAGES, SO THE ABOVE LIMITATION OR EXCLUSION MAY NOT APPLY TO THE PURCHASER.

How State and Provincial law(s) apply

This Limited Warranty gives you specific legal rights, and you may also have other rights which vary from jurisdiction to jurisdiction. The provisions of the United Nations Convention on Contracts for the Sale of Goods shall not apply to this Limited Warranty or the sale of products covered by this Limited Warranty.

We value your feedback!

Your input helps to create even better products and experiences.

Share the warmth and leave a review.

dimplex.com/sharethewarmth

 [YouTube/Dimplex](https://www.youtube.com/Dimplex) 



QR label

For more information on the Flame Connect app, visit dimplex.com/fcapp



1-888-346-7539 | www.dimplex.com

In keeping with our policy of continuous product improvement, we reserve the right to make changes without notice.

© 2022 Glen Dimplex Americas

 A BRAND OF GLEN DIMPLEX AMERICAS