

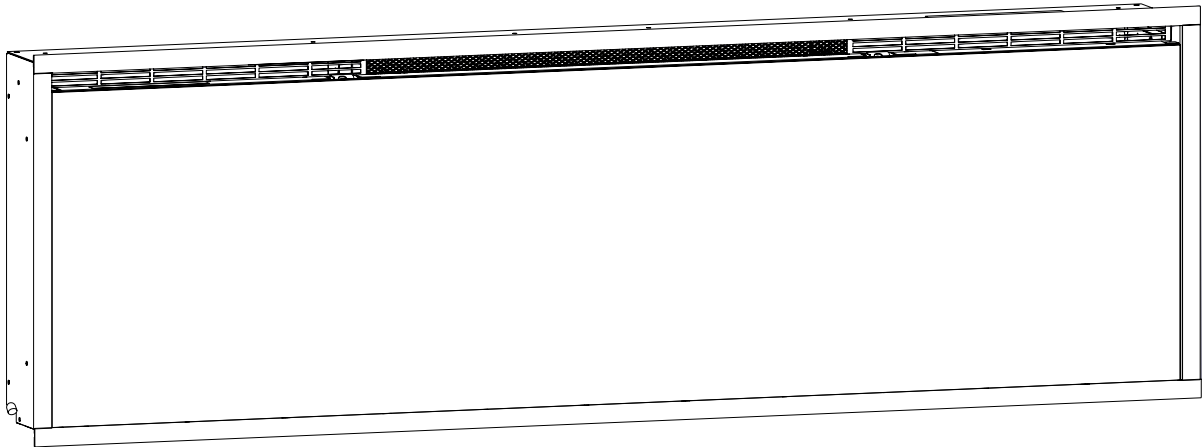

## Service Manual

	UL Part Number
<b>50" Model:</b> 500002573	6914080100
<b>60" Model:</b> 500002574	6914090100
<b>74" Model:</b> 500002608	6914100100
<b>100" Model:</b> 500002563	6914110100





























**IMPORTANT SAFETY INFORMATION:** Always read this manual first before attempting to service this fireplace. For your safety, always comply with all warnings and safety instructions contained in this manual to prevent personal injury or property damage.

# Table of Contents

---

<b>Operation</b> .....	<b>3</b>
Remote Operation .....	3
<b>Maintenance</b> .....	<b>5</b>
Cleaning .....	5
Remote Control Battery Replacement .....	5
<b>Exploded Parts Diagram</b> .....	<b>6</b>
500002573 (50" Model) .....	6
500002574 (60" Model) .....	7
500002608 (74" Model) .....	8
500002563 (100" Model) .....	9
<b>Wiring Diagrams</b> .....	<b>10</b>
500002573 (50" Model) .....	10
500002574 (60" Model) .....	10
500002608 (74" Model) .....	11
500002563 (100" Model) .....	11
<b>Replacement Part Procedures</b> .....	<b>12</b>
Preparation for Service .....	12
Control Board Replacement .....	13
Adapter Board Replacement .....	13
Power Supply Replacement .....	13
Capacitive Controls and Display Replacement .....	13
Media LED Light Strips Replacement .....	14
Flame LED Strips Replacement .....	14
Flicker Assembly Replacement .....	14
Flicker Motor Replacement .....	15
Temperature Sensor (NTC) Replacement .....	15
Heater Assembly Replacement .....	15
<b>Troubleshooting</b> .....	<b>16</b>
App .....	17

# Operation

	Standby	Press  to turn on the unit or to put it in standby mode. When the unit is turned back on, it will retain the previously used settings.
	Flame Effect	Press  to turn the flame effect, media, and media accent lights on or off.
	Heat	Press  to turn the heat on or off. The fireplace will beep once and the  icon will remain on the display when activated. The fireplace can be operated in heat only mode by turning off the flame and color effects.
	Heat Disable	Press and hold  and  at the same time for 3 seconds to disable or enable the heat function. This action must be performed on the <b>hidden touch controls</b> . When the heat is disabled and either the  ,  , or  is pressed, --- will appear on the display.
	Temperature Increase	Press  to increase the temperature setting.
	Temperature Decrease	Press  to decrease the temperature setting.
	Temperature Display (°C °F)	The temperature can be set from 7° C to 30° C (45° F to 86° F). When the temperature setting is adjusted, the set temperature will flash for 2 seconds, then the ambient room temperature will be displayed briefly.
	Temperature Display (°C °F)	Press and hold  and  at the same time for 3 seconds. This action must be performed on the <b>hidden touch controls</b> .
	Flame Speed	Press  repeatedly to cycle through the 5 different flame speeds.
	Heat Mode	Press  repeatedly to cycle through the 4 different heater modes: <b>Normal:</b> The element will automatically adjust itself to achieve and maintain the set temperature. <b>Heat Boost:</b> The element will work at maximum power for 20 minutes, then revert to normal heater mode. <b>Eco:</b> The element will work at reduced power to save energy. <b>Fan:</b> The element will turn off and only the fan will run.
	Moods	Press  repeatedly to cycle through the 8 different Moods, which are different combinations of overhead and media bed lighting. 1 - White 2 - Blue 3 - Violet 4 - Red 5 - Green 6 - Prism — media and media accent lights cycle through colors 7 - Kaleidoscope— media and media accent lights cycle through colors at different rates 8 - Midnight mode — media and media accent lights are off Press and hold  to turn the media accent lights on or off.
	Custom Color	Freeze the media and media accent lights to a custom color. When in Prism or Kaleidoscope modes (see Moods), press  while the desired color is displayed to freeze the cycle on that color. Press  again to resume the color cycle.

# Operation

	<p>Brightness</p>	<p>Press  repeatedly to cycle through the brightness and flicker modes.            Solid H - High Brightness            Solid L - Low Brightness            Cycle H - High Brightness with flickering media and media accent lights            Cycle L - Low Brightness with flickering media and media accent lights</p>
	<p>Flame Theme</p>	<p>Press  repeatedly to cycle through the 7 different flame themes:            1 - Base with orange and blue accents            2 - Base with orange accents            3 - Base with blue accents            4 - Blue            5 - Orange            6 - Base            7 - Orange and blue</p>
	<p>Ambient Light Sensor</p>	<p>Press  to turn the ambient light sensor on or off.            The ambient light sensor will automatically adjust the brightness of the fireplace lights based on the ambient light in the room.</p>
	<p>Timer</p>	<p>Press  repeatedly until the desired number of hours of the timer is displayed. When this function is active, the fireplace will turn off after a set amount of time. The timer can be set from 30 minutes (display will show .5) to 8 hours in intervals of 30 minutes. To turn the timer off, press  repeatedly until 0 appears on the display. While the timer is active, press the timer button to see the time remaining.</p>
<p>Factory Reset</p>		<p>Press and hold  and  at the same time for 3 seconds to reset all the settings to factory default. This action will also disconnect the unit from the Wi-Fi network if connected. This action must be performed on the <b>hidden touch controls</b>.</p>

Figure 1

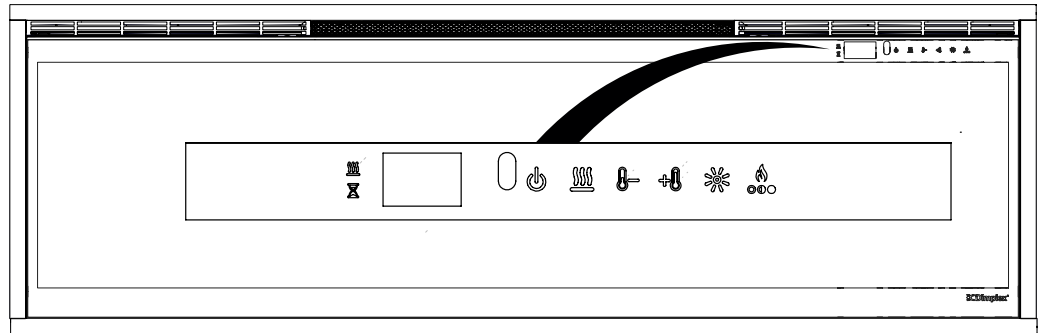
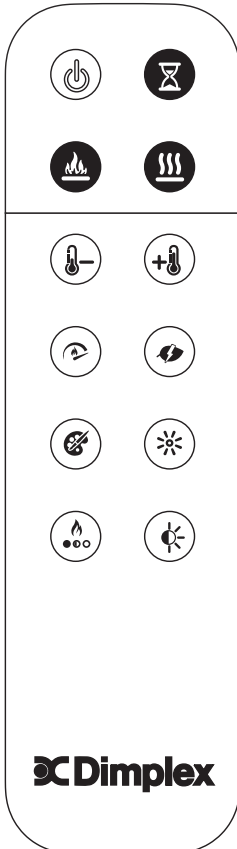

Figure 2

# Maintenance

---

**⚠ WARNING:** Disconnect power and allow heater to cool before attempting any maintenance or cleaning to reduce the risk of fire, electric shock or damage to persons.

**! NOTE:** The fireplace should not be operated with an accumulation of dust or dirt on or in the unit, as this can cause a build up of heat and eventual damage. For this reason the heater must be inspected regularly, depending upon conditions and at least at yearly intervals.

## Fireplace Surface Cleaning

Use only a damp cloth to clean painted surfaces of the fireplace. Do not use abrasive cleaners.

The fireplace should not be operated with an accumulation of dust or dirt on or in the unit, as this can cause a build-up of heat and eventual damage. For this reason the heater must be inspected regularly, depending upon conditions and at a minimum yearly intervals.

## Partially Reflective Glass Cleaning

The partially reflective glass is cleaned in the factory during the assembly operation. During shipment, installation, handling, etc., the partially reflective glass may collect dust particles; these can be removed by dusting lightly with a clean dry cloth.

To remove fingerprints or other marks, the partially reflective glass can be cleaned with a damp cloth. The partially reflective glass should be completely dried with a lint free cloth to prevent water spots. To prevent scratching, do not use abrasive cleaners.

### Fireplace Surface Cleaning

Use only a damp cloth to clean painted surfaces of the fireplace. Do not use abrasive cleaners.

### Servicing

Except for the cleaning and maintenance described on this page, an authorized service representative should perform any other servicing.

## Remote Control Battery Replacement

1. Remove battery cover of the remote control using a Philips screwdriver.
2. Correctly install one 3 Volt (CR2032 or similar) battery in the battery holder with the + side facing up.
3. Secure the battery cover using the previously removed screw.

Batteries must be recycled or disposed of properly. Check with your Local Authority or Retailer for recycling advice in your area.

# Exploded Parts Diagram

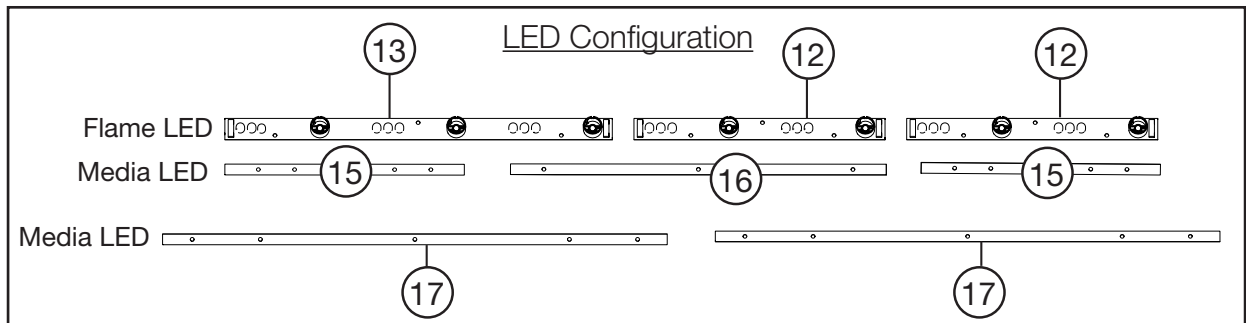
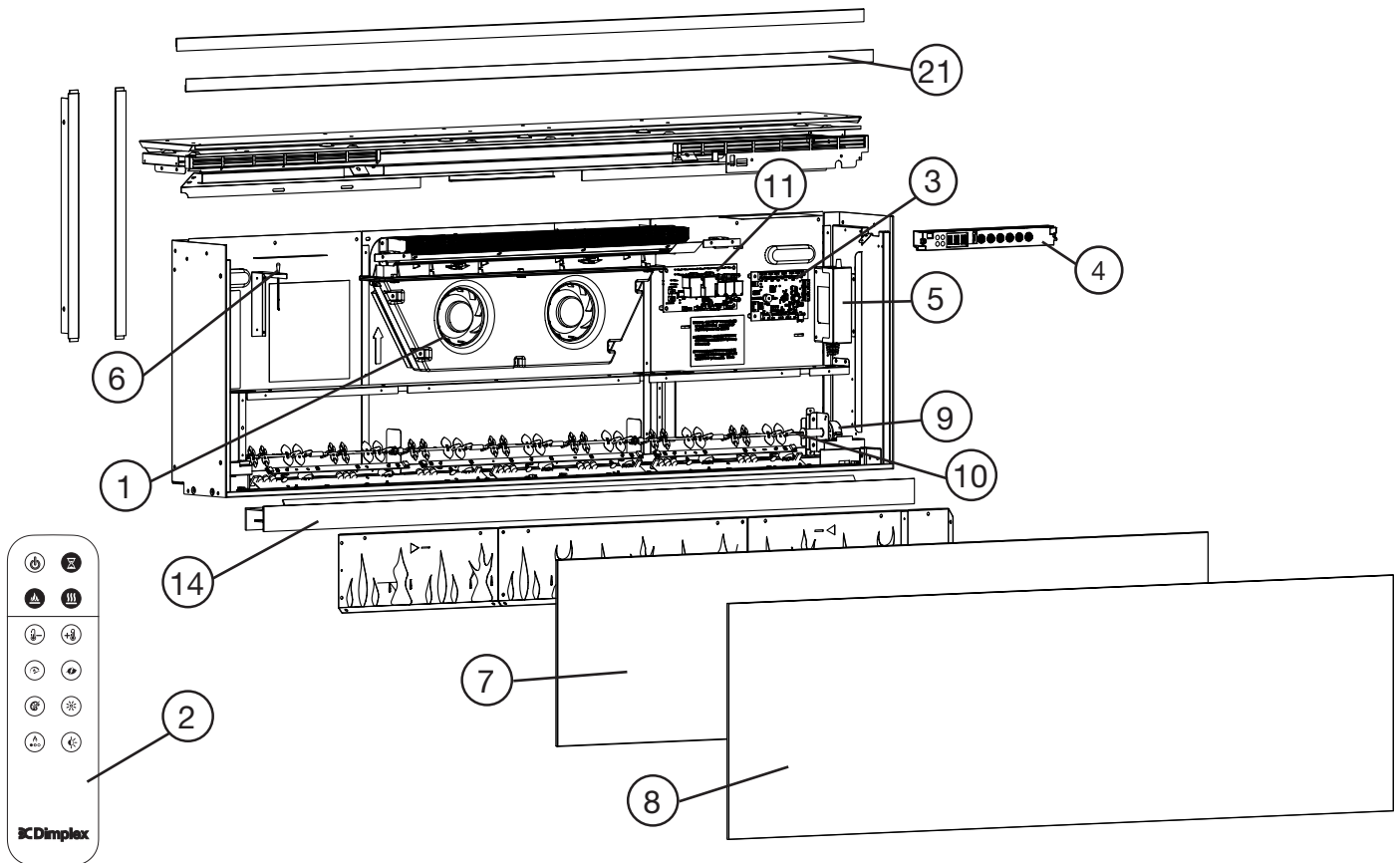

## Replacement Parts List - 500002573 (50" Model)

1. Heater Assembly . . . . .	500002950	13. Flame LED 6-Light Assembly . . . . .	500002615
2. Remote Control . . . . .	500002576	14. Media Tray . . . . .	X-5902910100RP
3. Control Board . . . . .	500002564	15. Media LED 4-Light Assembly (2) . .	X-3002350100RP
4. Capacitive Controls and Display . . . . .	500002575	16. Media LED 6-Light Assembly . . . . .	X-3002350200RP
5. Power Supply (5 Amp) . . . . .	X-2100250500RP	17. Media LED 8-Light Assembly (2) . .	X-3002350300RP
6. Temperature Sensor (NTC) . . . . .	500002352	18. Installation Hardware Kit . . . . .	500002609
7. Mirrored Glass . . . . .	500002568	19. Large Acrylic Media (3) . . . . .	X-1400130500RP
8. Front Glass . . . . .	500002566	20. Medium Acrylic Media . . . . .	X-1400150300RP
9. Flicker Motor . . . . .	X-2000550100RP	21. 4-piece Trim . . . . .	X-9602160100RP
10. Flicker Assembly . . . . .	500002610	22. Power Cord (MOD B) . . . . .	X-4100360100RP
11. Relay Board . . . . .	500002277	23. Tumbled Glass Media . . . . .	500002842
12. Flame LED 4-Light Assembly (2) . . . . .	500002606	24. Driftwood Media . . . . .	500002841

# Exploded Parts Diagram

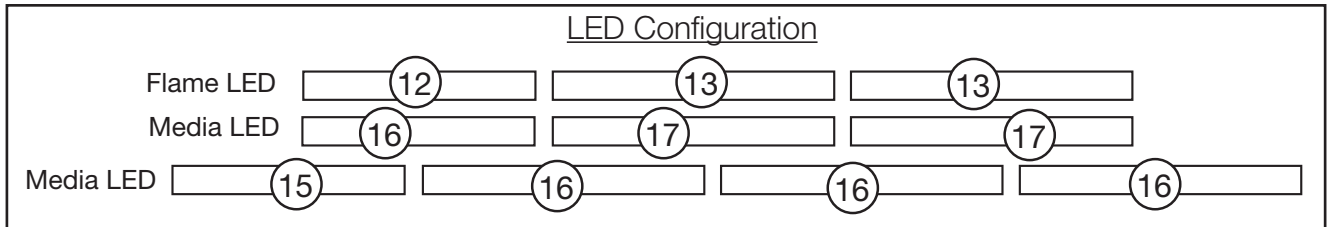
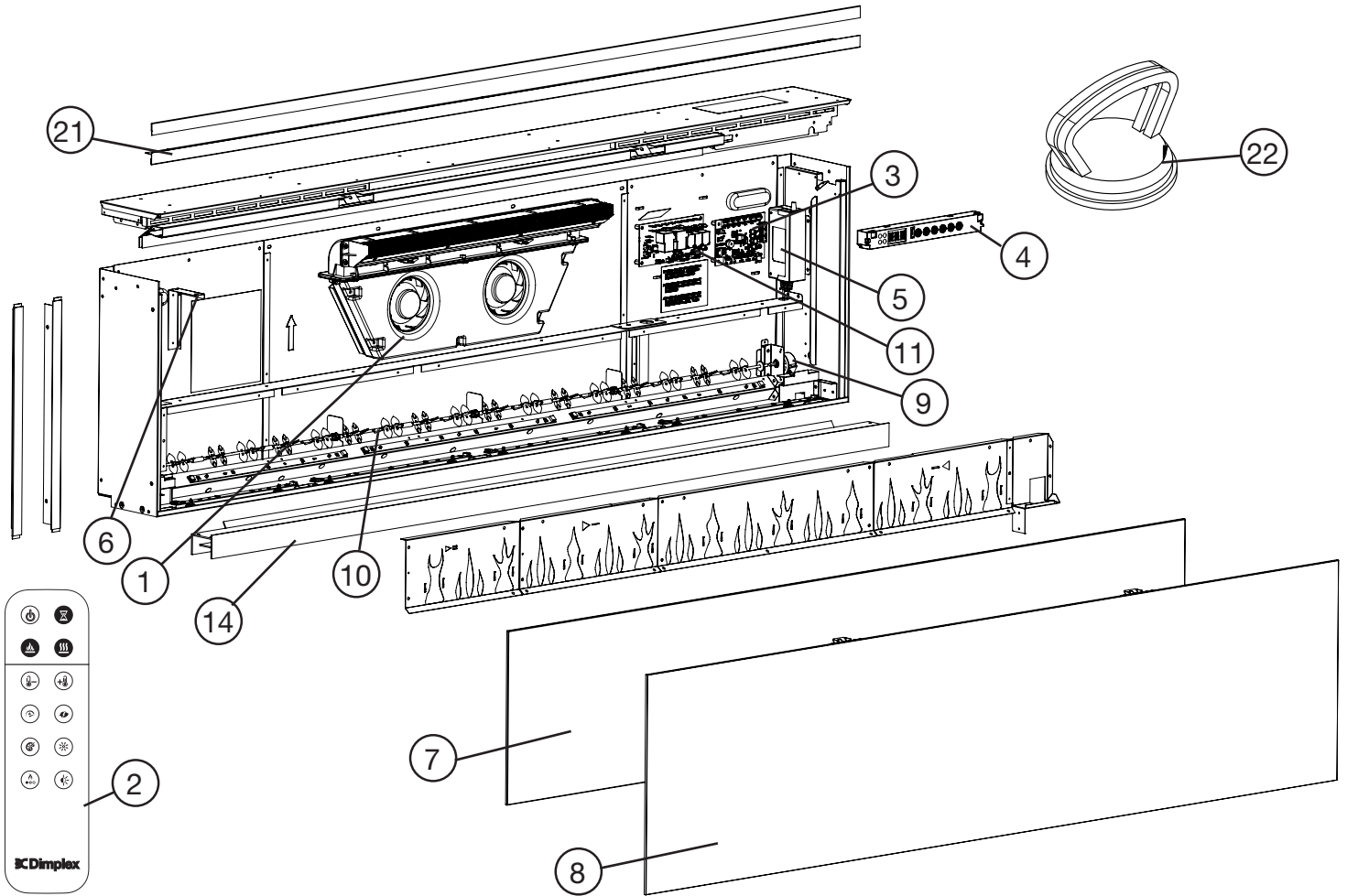

## Replacement Parts List - 500002574 (60" Model)

<p>1. Heater Assembly..... 500002950</p> <p>2. Remote Control..... 500002576</p> <p>3. Control Board..... 500002564</p> <p>4. Capacitive Controls and Display..... 500002702</p> <p>5. Power Supply (5 Amp)..... X-2100250500RP</p> <p>6. Temperature Sensor (NTC)..... 500002352</p> <p>7. Mirrored Glass..... 500002569</p> <p>8. Front Glass..... 500002577</p> <p>9. Flicker Motor..... X-2000550100RP</p> <p>10. Flicker Assembly..... 500002611</p> <p>11. Relay Board..... 500002277</p> <p>12. 5-Light LED Flame Assembly..... 500002614</p> <p>13. 6-Light LED Flame Assembly (2)..... 500002615</p> <p>14. Media Tray..... X-5902910400RP</p>	<p>15. 4-Light RGBW Media LED Assembly X-3002350100RP</p> <p>16. 5-Light RGBW Media LED Assembly (4)..... X-3002350400RP</p> <p>17. 6-Light RGBW Media LED Assembly (2)..... X-3002350200RP</p> <p>18. Installation Hardware Kit..... 500002609</p> <p>19. Large Acrylic Media (3)..... X-1400130500RP</p> <p>20. Medium Acrylic Media..... X-1400150300RP</p> <p>21. 4-piece Trim..... X-9602160200RP</p> <p>22. Suction Cup..... X-9600820100RP</p> <p>23. Power Cord (MOD B)..... X-4100360100RP</p> <p>24. Tumbled Glass Media..... 500002842</p> <p>25. Driftwood Media..... 500002841</p>
---	---

# Exploded Parts Diagram

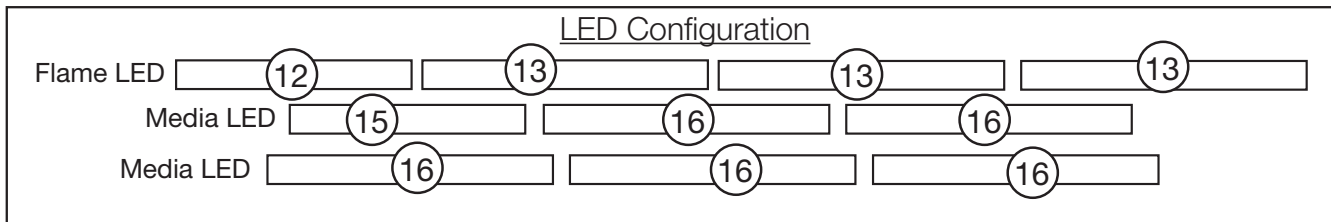
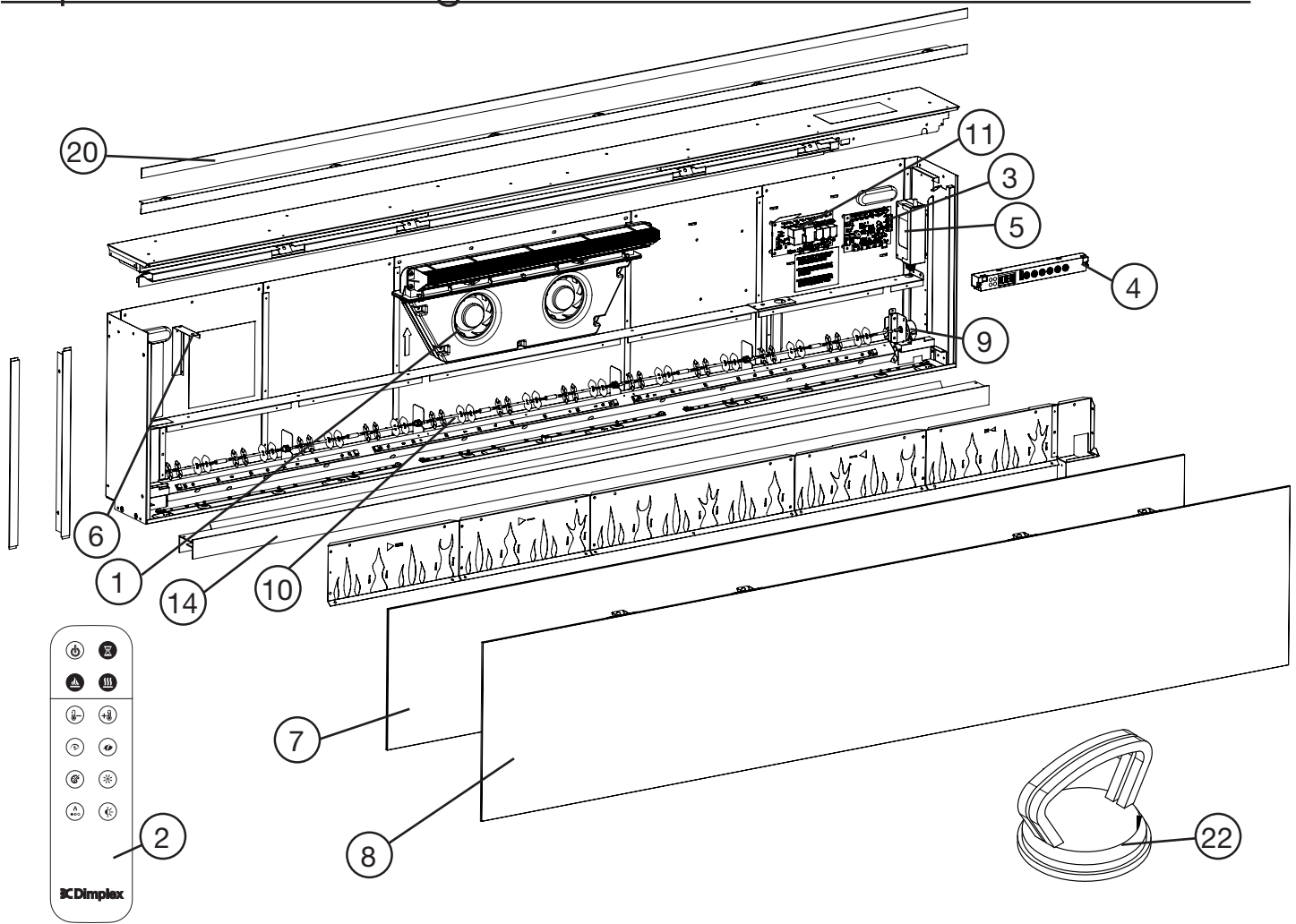

## Replacement Parts List - 500002608 (74" Model)

1. Heater Assembly . . . . .	500002950	14. Media Tray . . . . .	X-5902910200RP
2. Remote Control . . . . .	500002576	15. 6-Light RGBW Media LED Assembly	X-3002350200RP
3. Control Board . . . . .	500002564	16. 8-Light RGBW Media LED Assembly (5)	X-3002350300RP
4. Capacitive Controls and Display . . . . .	500002703		
5. Power Supply (5 Amp) . . . . .	X-2100250500RP	17. Installation Hardware Kit . . . . .	500002609
6. Temperature Sensor (NTC) . . . . .	500002886	18. Large Acrylic Media (4) . . . . .	X-1400130500RP
7. Mirrored Glass . . . . .	500002580	19. Medium Acrylic Media (2) . . . . .	X-1400150300RP
8. Front Glass . . . . .	500002578	20. 4-piece Trim . . . . .	X-9602160300RP
9. Flicker Motor . . . . .	X-2000550100RP	21. Suction Cup . . . . .	X-9600820100RP
10. Flicker Assembly . . . . .	500002612	22. Power Cord (MOD B) . . . . .	X-4100360100RP
11. Relay Board . . . . .	500002277	23. Tumbled Glass Media . . . . .	500002842
12. 4-Light LED Flame Assembly . . . . .	500002606	24. Driftwood Media . . . . .	500002841
13. 6-Light LED Flame Assembly (3) . . . . .	500002615		



# Exploded Parts Diagram

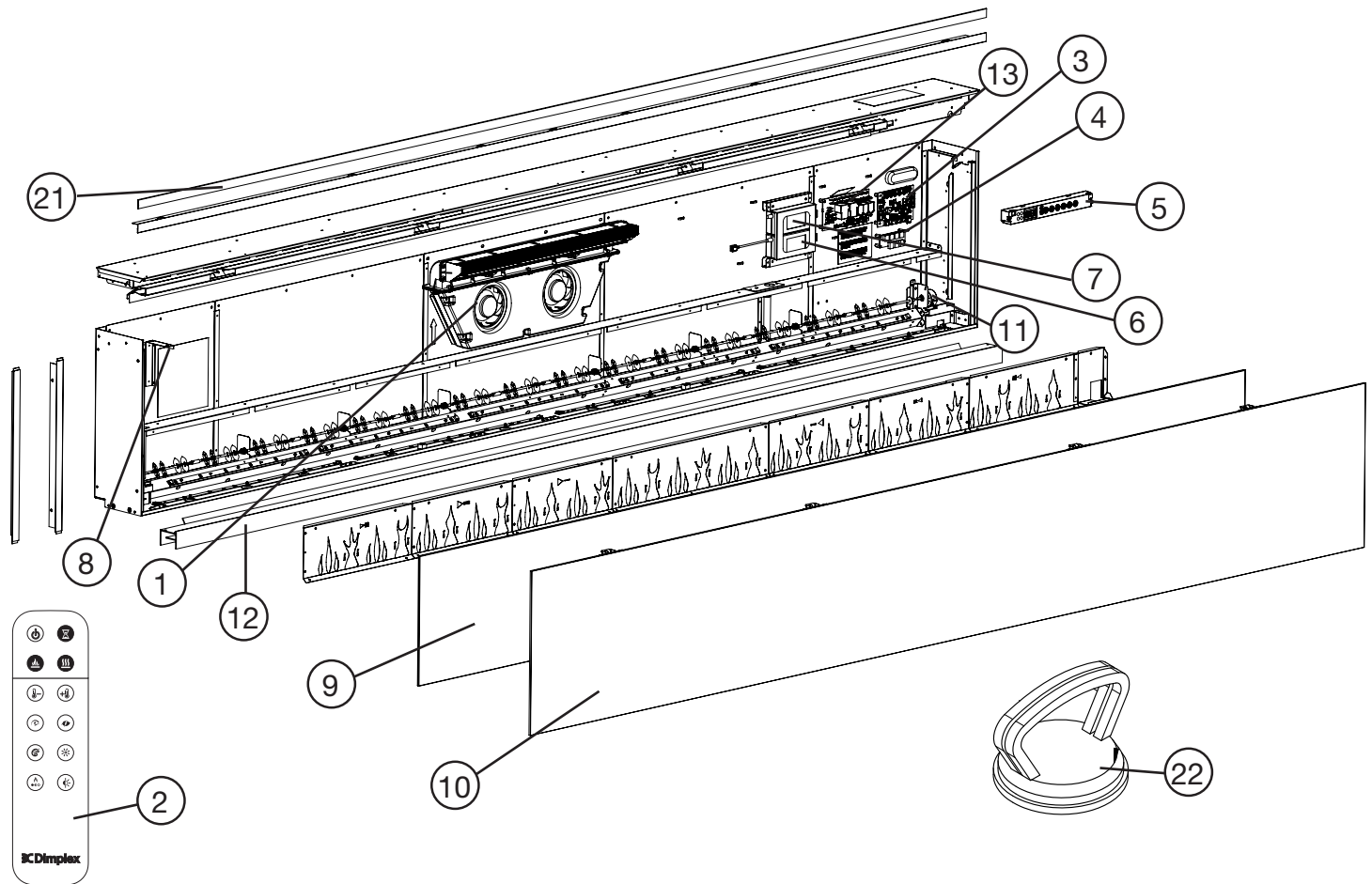

## LED Configuration

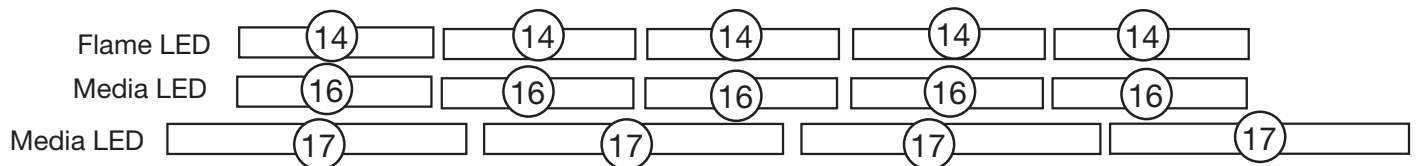

## Replacement Parts List - 500002563 (100" Model)

1. Heater Assembly.....	500002950	15. Media Tray .....	X-5902910300RP
2. Remote Control.....	500002576	16. 6-Light RGBW Media LED Assembly (5) .....	X-3002350200RP
3. Control Board .....	500002564	17. 8-Light RGBW Media LED Assembly (4) .....	X-3002350300RP
4. Adapter Board .....	X-3002400100RP	18. Installation Hardware Kit.....	500002609
5. Capacitive Controls and Display.....	500002704	19. Large Acrylic Media (5) .....	X-1400130500RP
6. Power Supply (5 Amp) .....	X-2100250500RP	20. Medium Acrylic Media (2) .....	X-1400150300RP
7. Power Supply (3 Amp) .....	X-2100250600RP	21. 4-piece Trim .....	X-9602160400RP
8. Temperature Sensor (NTC) .....	500002886	22. Suction Cup .....	X-9600820100RP
9. Mirrored Glass .....	500002581	23. Power Cord (MOD B) .....	X-4100360100RP
10. Front Glass .....	500002567	24. Tumbled Glass Media.....	500002842
11. Flicker Motor.....	X-2000550100RP	25. Driftwood Media .....	500002841
12. Flicker Assembly .....	500002613		
13. Relay Board .....	500002277		
14. 6-Light LED Flame Assembly (5).....	500002615		

# Wiring Diagrams

## 500002573 (50" Model)

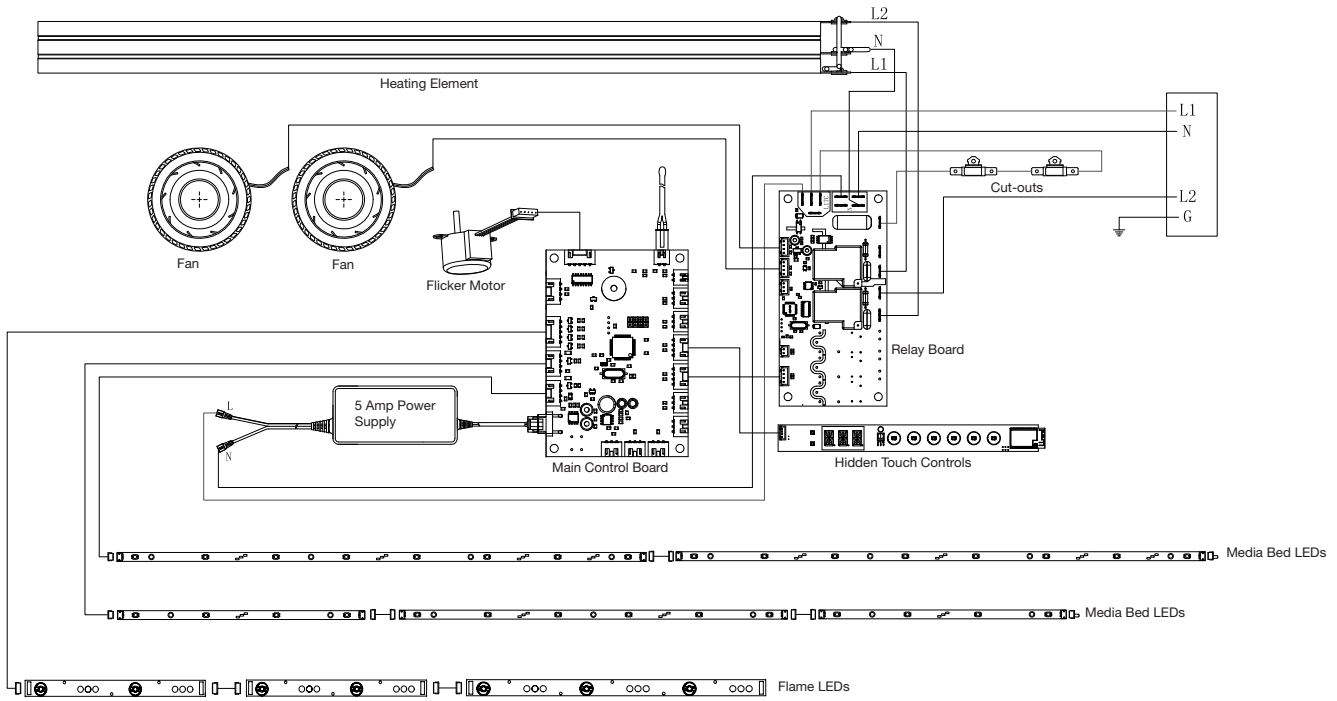

## 500002574 (60" Model)

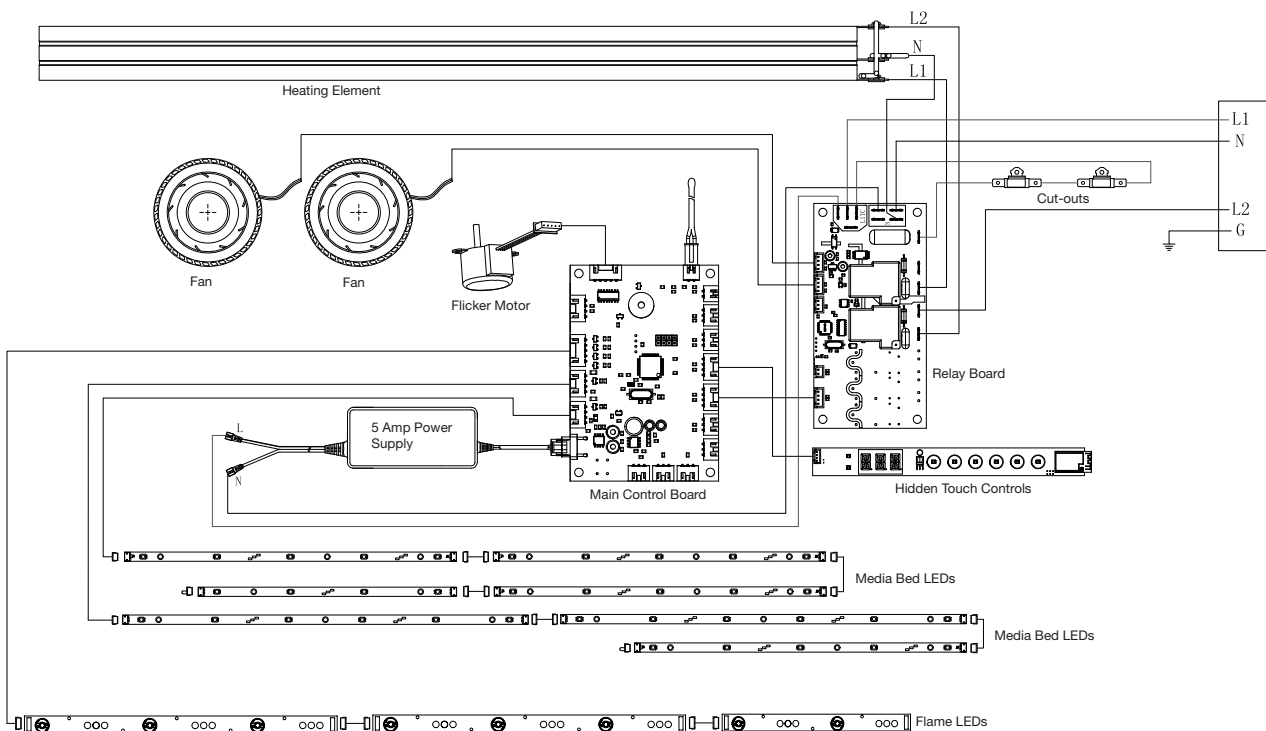

# Wiring Diagrams

## 500002608 (74" Model)

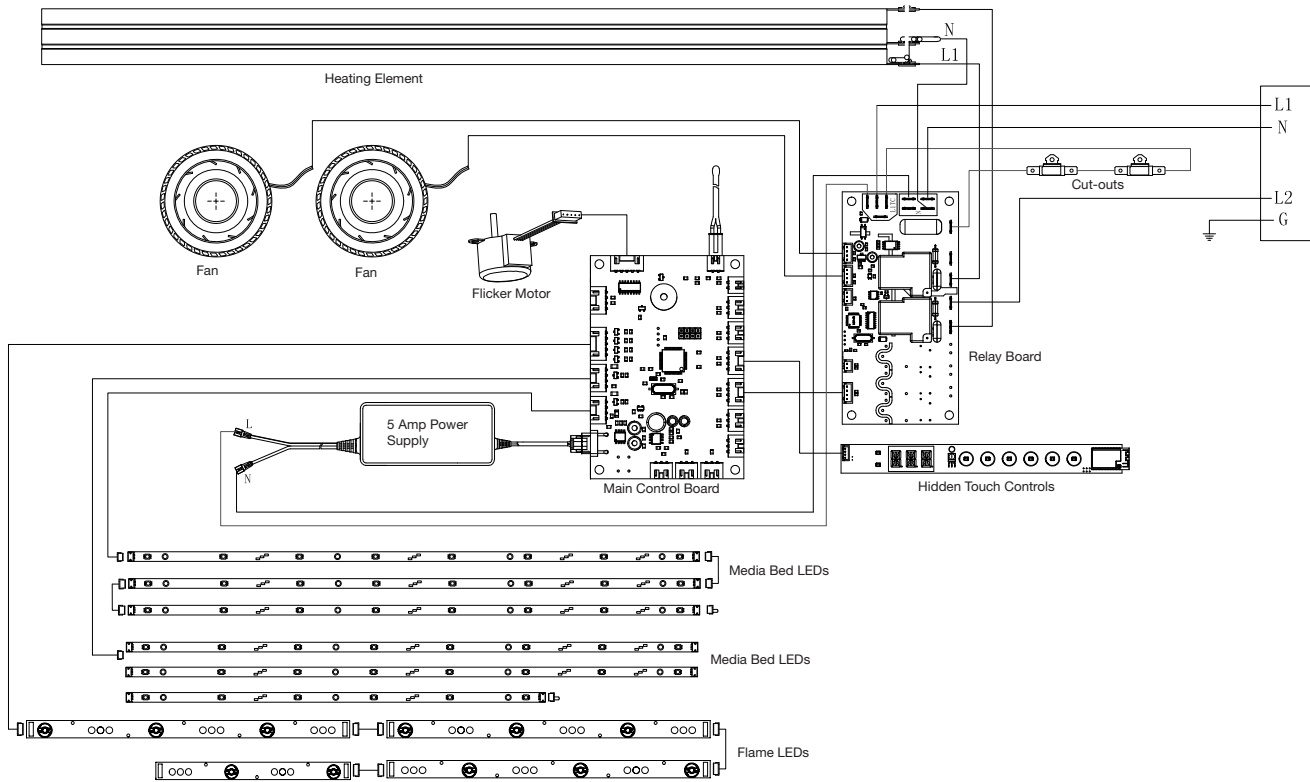

## 500002563 (100" Model)

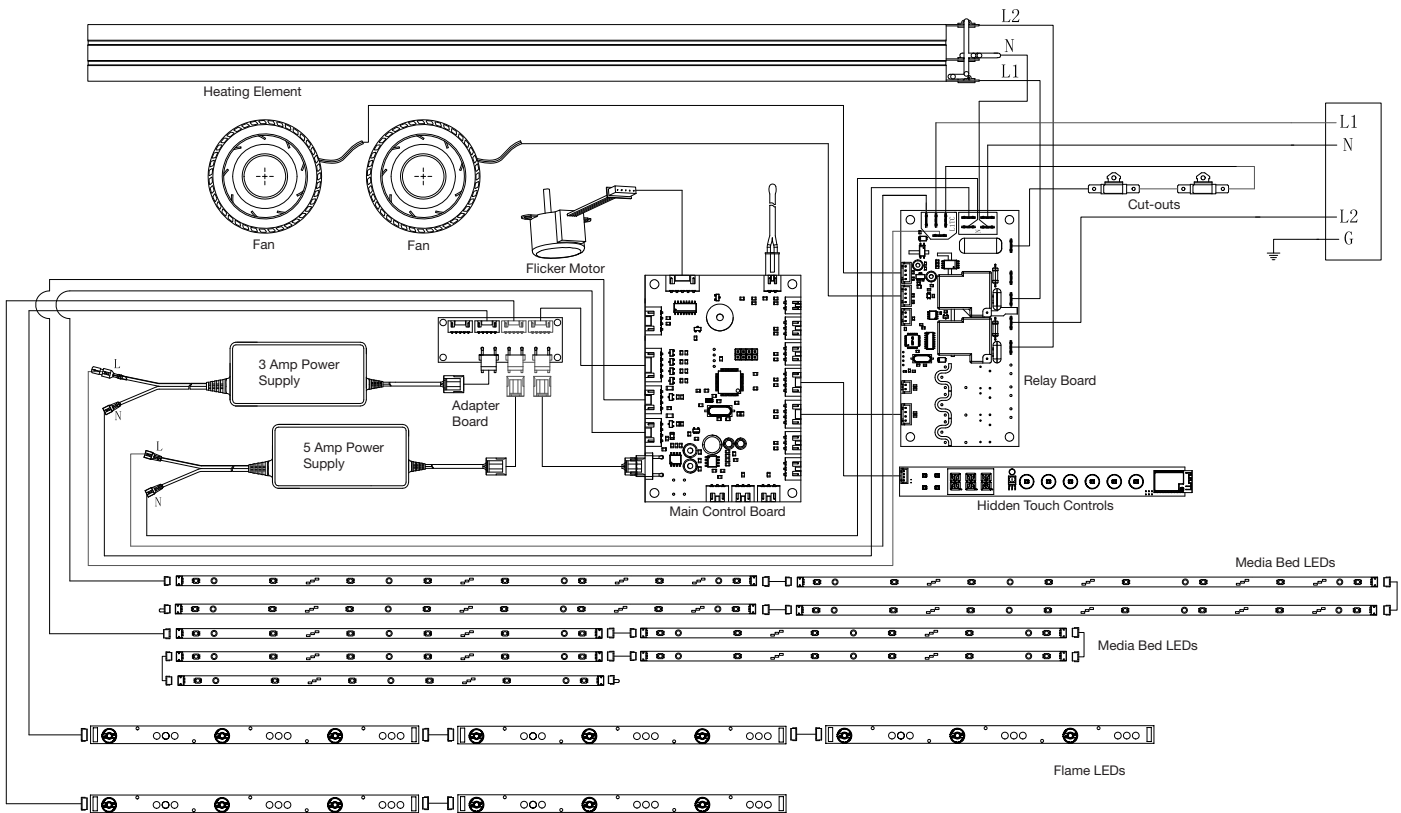

# Replacement Part Procedures

Figure 4

50" model 50.31 in [1278 mm]  
 60" model 60.31 in [1532 mm]  
 74" model 74.31 in [1887 mm]  
 100" model 100.31 in [2548 mm]

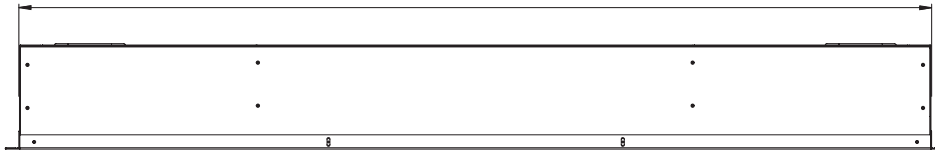

Figure 6

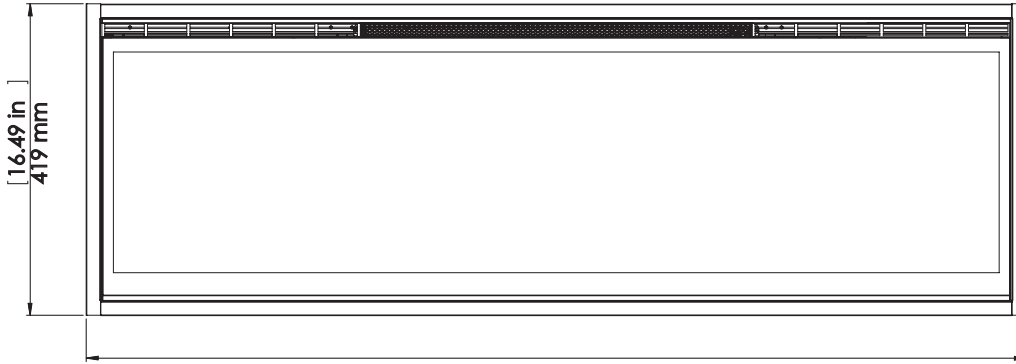
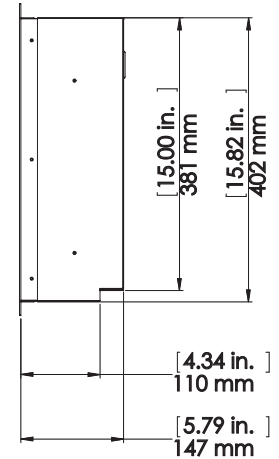

Figure 5

50" model 51.41 in [1306 mm]  
 60" model 61.41 in [1560 mm]  
 74" model 75.41 in [1941 mm]  
 100" model 101.41 in [2576 mm]

## Preparation for Service

**⚠ WARNING:** Disconnect power before attempting any maintenance or cleaning to reduce the risk of electric shock or damage to persons.

**⚠ CAUTION:** If unit was operating prior to servicing allow at least 10 minutes for lights and heating elements to cool off to avoid accidental burning of skin.

**Tools Required:** Philips head screwdriver and 2.5 mm hex key.

**! NOTE:** All components are replaceable from the front of the fireplace while the unit is mounted in the wall.

**! NOTE:** Be careful to not damage the springs behind the capacitive controls and display board at the top right hand side of the unit when performing service.

1. Turn the breaker off at the electrical panel.
2. Remove the front glass assembly by removing all screws (located just inside the top front vent opening). These screws secure the front glass panel to the inside of the fireplace.
3. Lift the front glass assembly out of the unit and carefully place the glass assembly aside in a safe location.
4. Remove the decorative media from the media tray, which lies along the bottom of the interior partially reflective glass. A medium sized container such as a bucket or a box will be needed to keep the decorative media together.

5. Attach the suction cup to the partially reflective glass to assist with removal (500002608 & 500002563.)
  6. Remove the screws from the glass retaining bracket, starting on either end and working your way to the middle, along the top of the opening, ensuring that neither the bracket nor the partially reflective glass falls out of the unit.
  7. Gently lift the partially reflective glass out of the unit and set it aside in a safe place. (Figure 7)
- ⚠ CAUTION:** The mirror is fragile and should not be bumped or dropped.
8. Proceed to the instructions within this manual relating to the repair being performed - see Table of Contents for page number.

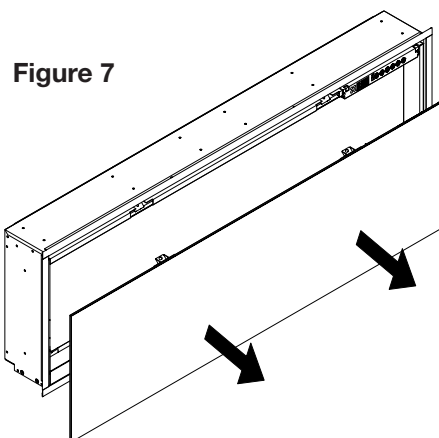

Figure 7

# Replacement Part Procedures

## Control Board Replacement

**Tools required:** Phillips head screwdriver

1. Follow “Preparation for Service” instructions before proceeding.
2. Locate the control board. (Figure 8)
3. Transfer the connections from the old board to the new board.
4. Remove the board, by removing the screw on each corner.
5. Install the new board onto the unit.
6. Ensure that all wires are replaced in the same manner as prior to the service.
7. Reassemble in the reverse order as above.

**Figure 8**

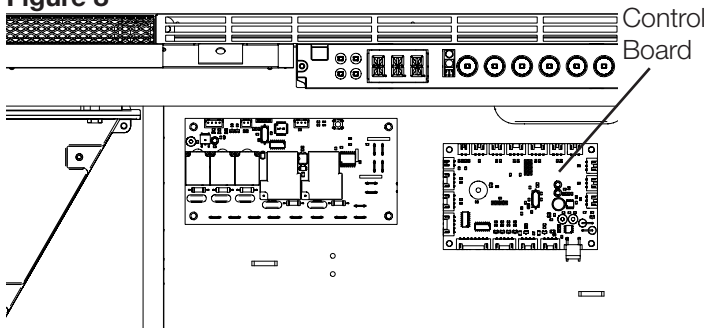

## Adapter Board Replacement (Only 500002563)

**Tools required:** Phillips head screwdriver

1. Follow “Preparation for Service” instructions before proceeding.
2. Locate the adapter board. (Figure 9)
3. Transfer the connections from the old board to the new board.
4. Remove the board, by removing the screw on each end.
5. Install the new board onto the unit.
6. Ensure that all wires are replaced in the same manner as prior to the service.
7. Reassemble in the reverse order as above.

**Figure 9**

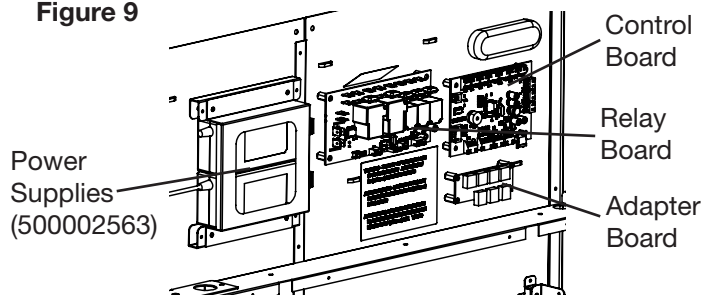

## Power Supply Replacement

**Tools required:** Phillips head screwdriver

1. Follow “Preparation for Service” instructions before proceeding.
2. Locate the power supply(s). (Figure 9 & 10)
3. Remove the screws that secure the holding bracket and power supply to the unit.
4. Trace the wires to the control board and disconnect.
5. Run the wiring from the new power supply to the control board.
6. Reinstall the bracket.
7. Ensure that all wires are replaced in the same manner as prior to the service.
8. Reassemble in the reverse order as above.

**Figure 10**

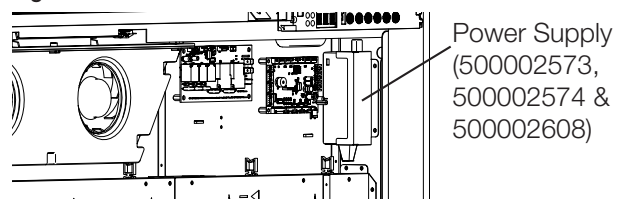

## Capacitive Controls and Display Replacement

**Tools required:** Phillips head screwdriver

1. Follow “Preparation for Service” instructions before proceeding.
2. Locate the controls and display assembly and remove the 2 securing screws. (Figure 10)
3. Gently remove the assembly from the unit by pulling it forward.
4. Disconnect the wire from the old assembly and install it on the new assembly.
5. Reinstall the new assembly onto the unit.
6. Ensure that all wires are replaced in the same manner as prior to the service.
7. Reassemble in the reverse order as above.
8. Place the new QR code stickers over the label on the fireplace, and on the back of the Owner's Manual.
9. Relink your fireplace to the Flame Connect App if desired. Visit [dimplex.com/fcapp](http://dimplex.com/fcapp) for more information.

**Figure 10**

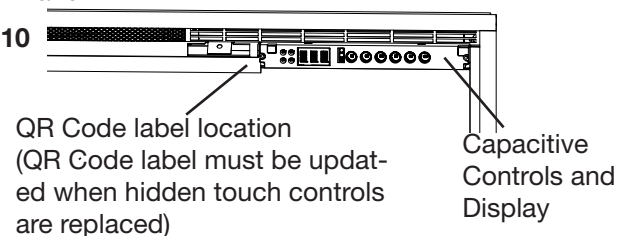

# Replacement Part Procedures

## Media LED Light Strips Replacement

**Tools required:** Phillips head screwdriver  
Needle nose pliers

1. Follow "Preparation for Service" instructions before proceeding.
2. Remove the plastic media tray by removing all screws. (Figure 11)
3. Lift the plastic media tray out of the unit.
4. Locate the LED assembly that needs to be removed.
5. Disconnect the wiring connections at either end.
6. Remove the assembly by pinching the plastic mounting tabs with needle nose pliers and lifting off.
7. Install the new assembly onto the unit and secure the LED strip to the unit.
8. Reattach the wire connections.
9. Ensure that all wires are replaced in the same manner as prior to the service.
10. Reassemble in the reverse order as above.

**Figure 11** Media Tray Screws

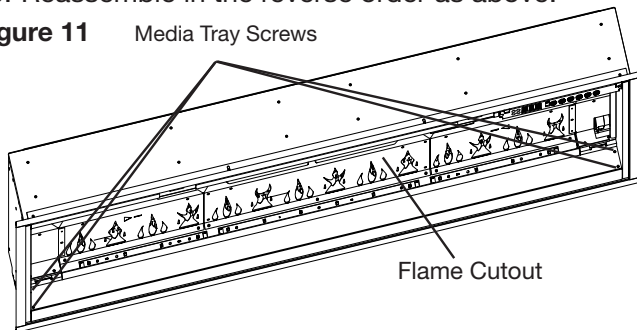

## Flame LED Strips Replacement

**Tools required:** Phillips head screwdriver  
Wire cutters

1. Follow "Preparation for Service" instructions before proceeding.
2. Remove the plastic media tray by removing all the screws on both ends. (Figure 11)
3. Lift the plastic media tray out of the unit.
4. Remove the upper access panel by removing all the screws. (Figure 14, page 15)
5. Remove the screws along the top of the flame cutout and gently remove. (Figure 11)
6. Locate the LED strip that needs to be removed.
7. Disconnect the wiring connections at either end.
8. Remove the LED strip by pinching the plastic mounting tabs with needle nose pliers and lifting off.
9. If lenses are not present on the new LED strip follow the following two steps before proceeding to step 10. (Figure 12)

I. Remove the lenses from the old LED strip (Figure 12)  
This will require some force when they are removed for the first time. It may be helpful to use a flathead screw driver to remove them.

II. Affix the lens to the new LED strip by aligning it over the LED light and pressing down on it.

**! NOTE:** Connect the LED referencing each end of the strip labeled as J1/J2.

10. Install the new assembly and connect J1 to J2.  
Secure the LED strip to the unit.
11. Reattach the wire connections.
12. Ensure that all wires are replaced in the same manner as prior to the service.
13. Reassemble in the reverse order as above.

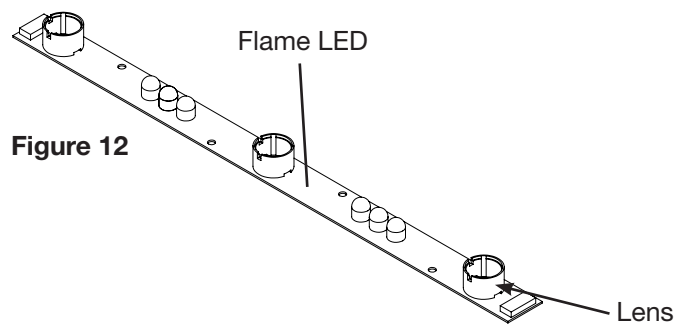

**Figure 12**

## Flicker Assembly Replacement

**Tools required:** Phillips head screwdriver

1. Follow "Preparation for Service" instructions before proceeding.
2. Remove the plastic media tray by removing all the screws on both ends. (Figure 11)
3. Lift the plastic media tray out of the unit.
4. Remove the screws along the flame cutout.
5. Remove the upper access panel by removing all the screws. (Figure 14, page 15)
6. Squeeze the bushing and push it to the right to release it from the bracket. Now pull the bushings off once you reach the thinnest part of the rod. (Figure 13, Page 15)  
**! NOTE:** Save these bushings for the new flicker rod.
7. Gently pull the motor away from the flicker rod.  
**! CAUTION:** When removing and replacing the flicker assembly try to keep any slight bending of the flicker rod minimal to avoid any possible damage. If the flicker assembly is damaged, it should be replaced to ensure proper operation.
8. Ensure that all wires are replaced in the same manner as prior to the service.
9. Reassemble in the reverse order as above.

# Replacement Part Procedures

Figure 13

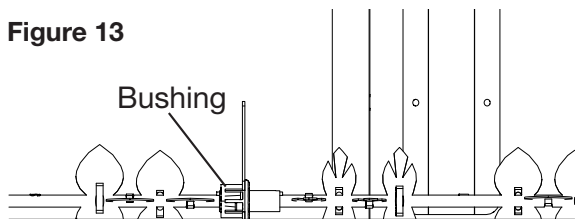

## Flicker Motor Replacement

**Tools required:** Phillips head screwdriver  
Short handled Phillips head screwdriver

1. Follow "Preparation for Service" instructions before proceeding.
  2. Remove the plastic media tray by removing the 4 screws: 2 on the left and 2 on the right of the tray.
  3. Lift the plastic media tray out of the unit.
  4. Remove the upper access panel located on the bottom right hand side by removing the screws securing it to the unit. (Figure 14)
  5. Remove the flicker motor mounting bracket from the unit.
  6. Remove the 2 screws holding the flicker motor to the mounting bracket. Gently pull the motor away from the flicker rod.
  7. Trace the wiring up to the control board and replace with new wires.
  8. Properly orient the new flicker motor onto the motor bracket and re-attach with the 2 mounting screws.
- ⚠ CAUTION:** When removing and replacing the flicker motor try to keep any slight bending of the flicker rod minimal so as to not damage it. If flicker rod is damaged, it should be replaced to ensure proper operation.
9. Reassemble in the reverse order as above.

Figure 14

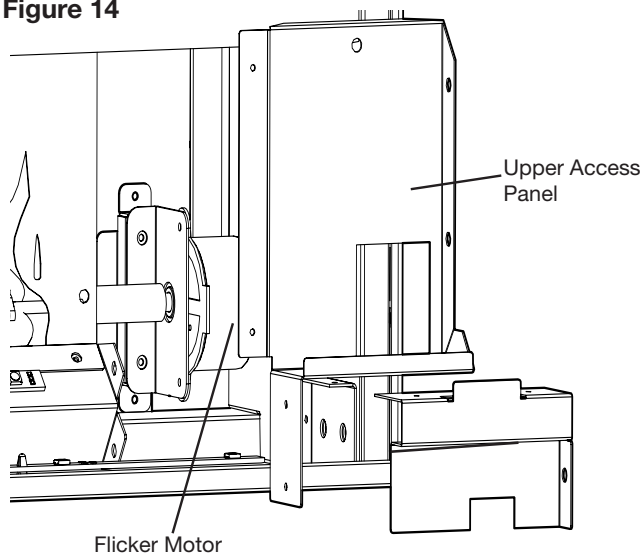

## Temperature Sensor (NTC) Replacement

**Tools required:** Phillips head screwdriver

1. Follow "Preparation for Service" instructions before proceeding.
2. Locate the temperature sensor attached to the bracket in the upper left hand side of the unit.
3. Remove the temperature sensor by cutting the tie wrap securing it to the standoff.
4. Follow the cable back to the control board and disconnect the old temperature sensor and connect the new cable.
5. Rerun the temperature sensor back to the bracket ensuring that the wiring is replaced in the original locations.
6. Ensure that all wires are replaced in the same manner as prior to the service.
7. Reassemble in the reverse order as above.

## Heater Assembly Replacement



**Tools required:** Phillips head screwdriver  
Needle nosed pliers

1. Follow "Preparation for Service" instructions before proceeding.
  2. Remove all screws that secure the heater assembly retaining bracket to the unit. Remove the bracket and set aside.
  3. Locate and remove the 4 screws that secure the assembly to the unit. (Figure 15)
- ⚠ CAUTION:** When removing the blower assembly mounting screws support the assembly to prevent any damage to the unit.
4. Disconnect the wiring connections, noting their original locations.
- ! NOTE:** Using a flat head screwdriver gently pry between the end of the connectors and the blower/fan to release the wires.
5. Properly orient the new heater assembly and connect all of the wiring connections.
  6. Secure any excess wire using the provided cable ties.
  7. Reassemble in the reverse order as above.

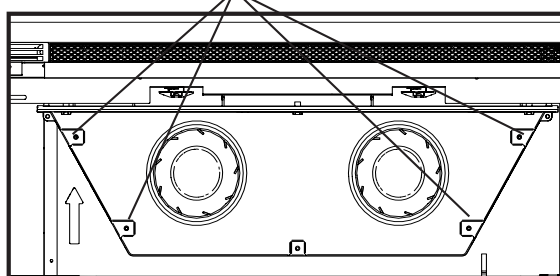
Figure 15 Heater Mounting Screws



# Troubleshooting

Problem	Display	Cause	Solution
Circuit breaker trips or fuse blows when unit is turned on	N/A	Improper circuit current rating	Install unit on a dedicated minimum 15 amp circuit.
Fireplace does not turn on with the manual touch controls	N/A	No incoming power	Ensure unit is wired correctly Check main disconnect panel Ensure wall switch is on (if applicable)
		Front glass was installed after unit was powered on	Turn power off (from breaker or outlet), install front glass before turning power back on.
		Defective hidden touch controls	Replace hidden touch controls
		Defective control board	Replace control board
		Defective relay board	Replace relay board
Fireplace does not turn on with the remote control	N/A	The batteries in the remote control are dead or installed incorrectly	Replace remote control battery Ensure battery is installed with + facing up.
		Defective Power Supply	Replace Power Supply
		Defective remote control	Replace remote control
		Defective IR receiver	Replace hidden touch controls
Heater does not turn on	---	Heater is disabled	Press and hold  and  at the same time on the hidden touch controls for 3 seconds to disable or enable the heat function.
	H—	Heater has been permanently disabled	If installation with heat is desired, jumper on main board if available or purchase new main board.
Heater is on, but there is no heat		Normal operation — There is a 30-second delay before heater starts	No action required.
		Thermostat setting is below ambient temperature	Turn up the thermostat setting to be above ambient temperature
Error Code is displayed	Err 1	Temperature cut-out is activated	Reset breaker and wait 30 minutes before turning unit back on it. Ensure heater intakes and exhausts are not obstructed. Clean with compressed air if necessary. Defective heater assembly.
	Err 2	L1 voltage is too high	If error persists, consult an electrician.
	Err 3	L1 voltage is too low	If error persists, consult an electrician.
	Err 4	L1 current is too high	If error persists, consult an electrician.
	Err 5	Fan not detected	Fan wire is disconnected. Defective heater assembly. Defective relay board.
	Err 6	Fan error	Defective heater assembly.
	Err 7	Fan is slow	Clean fan. Defective heater assembly.
	Err 8	Element error	Defective heater assembly.
	Err 9	Element not detected	Element wire(s) is/are disconnected. Defective heater assembly.



Error Code is displayed	Err12	Ambient temperature is above 45° C (113° F)	No action required.
	Err13	Ambient temperature is below 45° C (113° F)	No action required.
	Err14	NTC error	NTC is unplugged. NTC is defective. Control board is defective.
	Err15	NTC has shorted	NTC is unplugged. NTC is defective.
	Err16	NTC not detected	NTC is unplugged. NTC is defective.
	Err17	Media bed LEDs defective	Defective Media Bed LEDs. Defective Control board
	Err18	Media accent lights defective	Defective Media accent lights. Defective Control board
	Err19	Media bed LEDs not detected	Media Bed LEDs disconnected. Defective Media Bed LEDs. Defective Control board
	Err 20	Media accent lights not detected	Media accent lights disconnected. Defective Media accent lights. Defective Control board
	Err 21	Flame LEDs not detected	Flame LEDs disconnected. Defective Flame LEDs. Defective Control board
	Err 22	Flicker motor not detected	Flicker motor is disconnected. Defective Flicker motor. Defective Control board .
	Err 23	Relay board not detected	Relay board is disconnected. Defective Relay board.
	Err 24	Control board not detected	Control board is disconnected. Defective Control board .
	Err 25	Display board not detected	Defective Display board. Defective Control board .

## App

For troubleshooting information related to the Flame Connect app, please visit [www.dimplex.com/fcapp](http://www.dimplex.com/fcapp)

1-888-346-7539 | [www.dimplex.com](http://www.dimplex.com)

In keeping with our policy of continuous product improvement, we reserve the right to make changes without notice.

© 2023 Glen Dimplex Americas

 A BRAND OF GLEN DIMPLEX AMERICAS

 **GlenDimplex**  
Americas