

Owner's Manual

Model

DFI2309

DFI2310







IMPORTANT SAFETY INFORMATION: Always read this manual first before attempting to install or use this fireplace. For your safety, always comply with all warnings and safety instructions contained in this manual to prevent personal injury or property damage.

To view the full line of Dimplex products, please visit www.dimplex.com

7205650300R04



Table of Contents

	Welcome & Congratulations	3
	IMPORTANT INSTRUCTIONS	4
	Fireplace Installation	7
	Operation	9
	Maintenance	11
	Warranty	13
	Technical Support.	16

Always use a qualified technician or service agency to repair this fireplace.

! NOTE: Procedures and techniques that are considered important enough to emphasize.

⚠ CAUTION: Procedures and techniques which, if not carefully followed, will result in damage to the equipment.

⚡ WARNING: Procedures and techniques which, if not carefully followed, will expose the user to the risk of fire, serious injury, or death.

Welcome & Congratulations

Thank you and congratulations for purchasing an electric fireplace from Dimplex. Please use our convenient online registration page to record your model and serial numbers for future reference at

www.dimplex.com/register

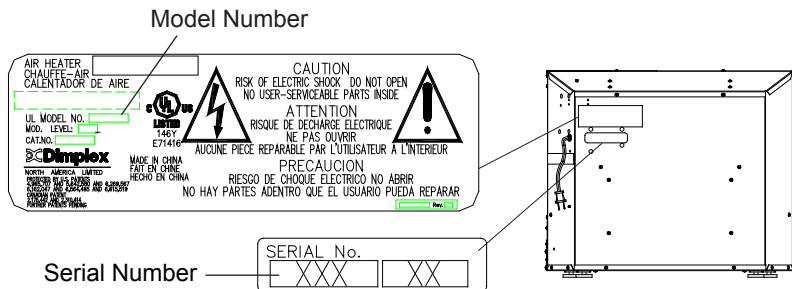

Please carefully read and save these instructions.

⚠ CAUTION: Read all instructions and warnings carefully before starting installation. Failure to follow these instructions may result in a possible electric shock, fire hazard and will void the warranty.



NO NEED TO RETURN TO THE STORE

Questions with operation or assembly? Require Parts Information?
Product Under Manufacturer's Warranty?

Contact us at:  www.dimplex.com/customer_support
For Troubleshooting and Technical Support

OR  **Toll-Free 1-888-DIMPLEX (1-888-346-7539)**

Monday to Friday 8:00 a.m. to 4:30 p.m. EST

In order to better serve you, please have your model and serial number ready or register your product online before calling (See above)



IMPORTANT INSTRUCTIONS

When using electrical appliances, basic precautions should always be followed to reduce the risk of fire, electric shock, and injury to persons, including the following:

- ① Read all instructions before using this heater.
- ② This heater is hot when in use. To avoid burns, do not let bare skin touch hot surfaces. The trim around the heater outlet becomes hot during heater operation. Keep combustible materials, such as furniture, pillows, bedding, papers, clothes, and curtains at least 3 feet (0.9 m) from the front of the heater and keep them away from the sides and rear.
- ③ Extreme caution is necessary when any heater is used by or near children or invalids and whenever the unit is left operating and unattended.
- ④ Always unplug the heater when not in use.
- ⑤ Do not operate any heater after it malfunctions. Disconnect power at the service panel and have the heater inspected by a reputable electrician before reusing.
- ⑥ Do not operate any unit with a damaged cord or plug, or if the heater has malfunctioned, or if the electric fireplace has been dropped or damaged in any manner, contact Dimplex Technical Service at 1-888-346-7539.
- ⑦ Do not use outdoors.
- ⑧ This heater is not intended for use in bathrooms, laundry areas and similar indoor locations. Never locate this heater where it may fall into a bathtub or other water container.
- ⑨ Do not run cord under carpeting. Do not cover cord with throw rugs, runners, or the like. Arrange cord away from traffic area and where it will not be tripped over.
- ⑩ To disconnect heater, turn controls to off, then remove plug from outlet.
- ⑪ Do not insert or allow foreign objects to enter any ventilation or exhaust opening as this may cause an electric shock or fire, or damage the heater.
- ⑫ To prevent a possible fire, do not block air intakes or exhaust in any manner.
- ⑬ All electrical heaters have hot and arcing or sparking parts

IMPORTANT INSTRUCTIONS

inside. Do not use in areas where gasoline, paint, or flammable liquids are used or stored.

⑭ Do not modify the heater. Use it only as described in this manual. Any other use not recommended by the manufacturer may cause fire, electric shock, or injury to persons.

⑮ This unit may have a polarized plug (one blade is wider than the other). The plug will fit in a polarized outlet only one way. If the plug does not fit fully in the outlet, reverse the plug. If it still does not fit, contact a qualified electrician to install the proper outlet.

⑯ Always plug heaters directly into a wall outlet/receptacle. Never use with an extension cord or relocatable power tap (outlet/power strip).

⑰ Do not burn wood or other materials in the Fireplace.

⑱ Do not strike the front glass.

⑲ Always use a certified electrician should new circuits or outlets be required.

⑳ Always use properly grounded, fused and polarized outlets.

㉑ Do not install the fireplace directly on carpet or a similar surface, which may restrict air circulation beneath the unit.

㉒ Disconnect all power supply before performing any cleaning, maintenance or relocation of the heater.

㉓ When transporting or storing the heater and cord, keep in a dry place, free from excessive vibration and store so as to avoid damage.



CAUTION
RISK OF ELECTRIC SHOCK
DO NOT OPEN
NO USER-SERVICEABLE PARTS INSIDE



SAVE THESE INSTRUCTIONS





IMPORTANT INSTRUCTIONS

This equipment has been tested and found to comply with the limits for Class B digital device, pursuant to part 15 of the FCC Rules. These limits are designed to provide reasonable protection against harmful interference in a residential installation. This equipment generates, uses and can radiate radio frequency energy and, if not installed and used in accordance with the instructions, may cause harmful interference to radio or television reception, which can be determined by turning the equipment off and on, the user is encouraged to try to correct the interference by one or more of the following measures:

- Reorient or relocate the receiving antenna.
- Increase the separation between the equipment and the receiver.
- Connect the equipment into an outlet on a circuit different from that to which the receiver is connected.
- Consult the dealer or an experienced radio/TV technician for help.

Operation is subject to the following two conditions: (1) this device may not cause interference and; (2) this device must accept any interference, including interference that may cause undesired operation of the device.

 **WARNING:** Remote control contains small batteries keep away from children. If swallowed seek medical attention immediately.

 **WARNING:** Do not install battery backwards, charge, put in fire or mix with used or other battery types - may explode or lead causing injury.

! **NOTE:** Changes or modifications not expressly approved by the party responsible for compliance could void user's authority to operate the equipment.



Fireplace Installation

⚠ WARNING: Ensure the power cord is not installed so that it is pinched or against a sharp edge and ensure that the power cord is stored or secured to avoid tripping or snagging to reduce the risk of fire, electric shock or injury to persons.

⚠ WARNING: Construction and electrical outlet wiring must comply with local building codes and other applicable regulations to reduce the risk of fire, electric shock and injury to persons.

⚠ WARNING: Do not attempt to wire your own new outlets or circuits. To reduce the risk of fire, electric shock or injury to persons, always use a licensed electrician.

⚠ WARNING: To reduce the risk of fire, do not store or use gasoline or other flammable vapors or liquids in the vicinity of the heater.

⚠ CAUTION: High temperature, risk of fire, keep electrical cords, drapery, furnishings, and other combustibles at least 3 ft (0.9 m) from the front of the heater.

! NOTE: A 15amp, 120-volt circuit is required. A dedicated circuit is preferred but not essential in all cases. A dedicated circuit will be required if, after installa-

tion, the circuit breaker trips or the fuse blows on a regular basis when the heater is operating. Additional appliances on the same circuit may exceed the current rating of the circuit breaker.

⚠ CAUTION: Clearance for air circulation beneath the fireplace insert is provided by two rubber feet. **Do not install the fireplace insert directly on carpet or similar surfaces which may restrict air circulation.**

⚠ CAUTION: If installing the fireplace in a carpeted area, place a one-piece, solid, flat surface under the fireplace. Ensure that both of the feet rest securely on this surface.

! NOTE: The electric insert must be installed in an opening with the **minimum** dimensions 24 in. (61 cm) wide, 21.5 in. (54.6 cm) high and 12 in. (30.5 cm) deep. The fireplace does not require any additional venting (Figure 1).

Existing Fireplace

1. Seal all drafts and vents with a non-fibrous insulation material to prevent any chimney debris from falling onto the fireplace. Do not install into an existing

Fireplace Installation

- fireplace that is prone to dampness.
2. Cap the top of the chimney flue to prevent rain from entering.
 3. Plan your electric power supply.
 4. Install an outlet into the existing fireplace. If an outlet is not installed into the existing fireplace the power cord can also run along the front of the hearth to an outlet near the fireplace.
 5. Ensure the insert power is off (see Operation). Plug the insert into the outlet and slide the unit into the existing fireplace.
 6. Push the insert into the firebox and center within the opening. Adjust the four feet on the bottom of the insert by turning counter clockwise to raise and clockwise to lower so that is level with the existing fireplace hearth.
 7. Install the trim kit onto the fireplace insert (if applicable) and push the trim and or insert back until the trim is flat against the finished wall.

⚠ WARNING: The fireplace insert can be used with existing fireplace and screens. Due to the heat produced from the heater, existing fireplace screens must provide adequate air flow in front of the unit. **Do not use existing fireplace doors that close, sealing off the fireplace insert from the room. If installed behind bi-fold doors, doors must be open to allow heat to be exhausted.**

WIRING

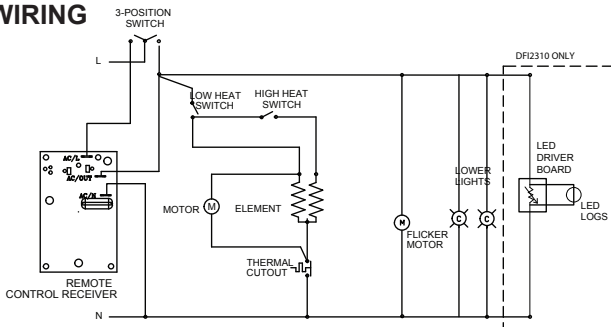

Operation

Figure 1

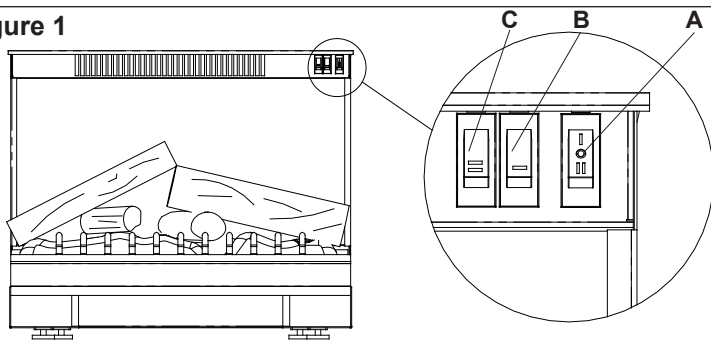

⚠ WARNING: This electric firebox must be properly installed before it is used.

Manual Controls

A - 3-Position Switch

The switch has two On positions marked with “ I ” and “ II ”. The “ I ” position is for manual operation. In this position the built-in remote control is bypassed.

The “ II ” position is for operating the unit with the provided remote control. When in “ II ” position the unit is operated with the ON and OFF buttons of the remote control.

When the switch is in the center (“ O ”) position the unit is off.

B - Low Heat On/Off Switch

The Low Heat On/Off Switch supplies power to the heater fan

and the heater element. When the switch is in the ON position the heater operates on LOW.

C - High Heat Switch

The High Heat On/Off Switch supplies power to the heater fan and the heater element, when the switch is in the ON position the heater operates on HIGH. The Low Heat Switch must also be in the ON position for the high heat setting to operate.

! NOTE: The heater on your fireplace may emit a slight, harmless odor when first used. This odor is a normal condition caused by the initial heating of internal heater parts and will not occur again.

Resetting the Temperature Cut-off Switch

The heater is protected with a

Operation

safety device to prevent overheating. Should the heater overheat, an automatic cut out will turn the heater off and it will not come back on without being reset. It can be reset by switching the 3-Position Switch (Figure 1A) to Off (“O” position) and waiting five minutes before switching the unit back on.

CAUTION: If you need to continuously reset the heater, unplug the unit and call your local dealer.

Remote Control (Figure 2)

The fireplace is supplied with an integrated On/Off remote control.

NOTE: Ensure that the fireplace’s 3-Position Switch is set to the remote control setting (“II” position).

Figure 2

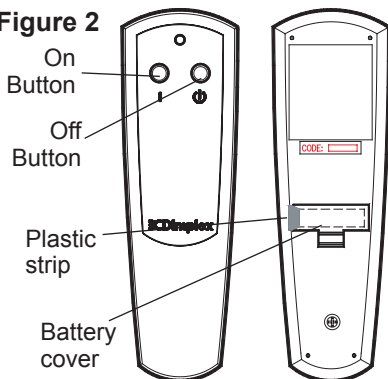

To operate, push the ON button to turn fireplace on, push the OFF button to turn the fireplace off.

NOTE: Before attempting any operation with the remote, pull the plastic insulator strip out from between the remote casing and battery cover

Remote Control Initialization/ Reprogramming

In the event that your remote control ceases to operate your fireplace, follow these steps to re-initialize the remote control and the remote control receiver in the fireplace:

1. Place the 3-Position Switch (Figure 1A) in the Off (“O”) position.
2. Wait a minimum of five seconds and then place the 3-Position Switch in the Remote Control (“II”) position.
3. Within 10 seconds of changing the switch position, press the ON button located on the remote control (Figure 2).

This will synchronize the remote control and the fireplace receiver.

NOTE: You will have only 10 seconds to perform this last step. Failure to do so will result

Operation

in these steps needing to be followed again.

Battery Replacement

To replace the battery:

1. Slide battery cover open on the hand held transmitter
2. Correctly install one 12 Volt (A23) battery in the battery

holder.

3. Close the battery cover.



Battery must be recycled or disposed of properly. Check with your Local Authority or Retailer for recycling advice in your area.



Maintenance

⚠ WARNING: Disconnect power before attempting any maintenance or cleaning to reduce the risk of fire, electric shock or damage to persons.

! NOTE: The fireplace should not be operated with an accumulation of dust or dirt on or in the unit, as this can cause a build up of heat and eventual damage. For this reason the heater must be inspected regularly, depending upon conditions and at least at yearly intervals.

Light Bulb Replacement

Light bulbs need to be replaced when you notice a dark section of the flame. There are two bulbs under the log set which generate the flames and embers.

Light Bulb Requirements

Quantity 2 clear chandelier or candelabra bulbs with an E-12 (small) socket base, 60 Watt rating. Example: GE 60BC or Philips 60CTC. **Do not exceed 60 Watts per bulb.**

Replacement:

⚠ CAUTION: Allow at least 10 minutes for the light bulbs and heater to cool before attempting any maintenance or cleaning.

1. With a Phillips screwdriver remove the screws from the Log Grate (Figure 3).
2. Remove the Log Set by lifting straight up.

! NOTE: Log Set fits tightly



Maintenance

into firebox, some force may be necessary to remove.

3. Disconnect the Log Set LED Wire Harness from the unit (DFI2310 only).
4. Unscrew the bulbs counter clockwise.
5. Insert and install new bulbs.
6. Reconnect the Log Set LED Wire Harness to unit (DFI2310 only).
7. Replace the Log Set into the insert.
8. Replace Log Grate and install screws from step 2.

Glass Cleaning

The glass is cleaned in the factory during the assembly operation. During shipment, installation, handling, etc., the glass surface may collect dust particles, these can be removed by buffing lightly with a clean dry cloth.

To remove fingerprints or other marks, the glass can be cleaned with a damp cloth using a good quality household glass cleaner. The glass should be completely dried with a lint free cloth or paper towel. Do not use abrasive cleaners on glass surface or spray

Figure 3

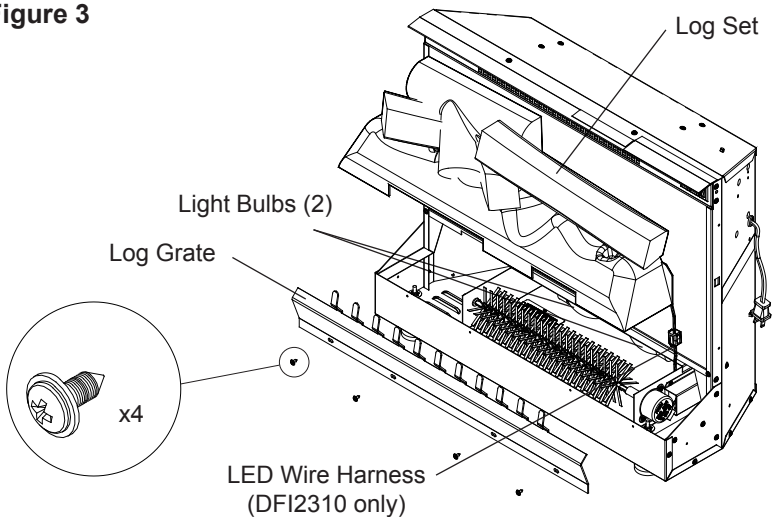



Maintenance

liquids directly onto any surface.

Fireplace Surface Cleaning

Use warm water only to clean painted surfaces of the Compact Fireplace. Do not use abrasive cleaners.

Servicing

Except for light bulb replacement and cleaning described above, an authorized service representative should perform any other servicing.



Warranty

One Year Limited Warranty

Products to which this limited warranty applies

This limited warranty applies to the following models of your newly purchased Dimplex electric fireplace **6901470100**, **DFI2309**, **6901470200**, **DFI2310** and to newly purchased Dimplex fireplace surrounds (mantels) and trims. This limited warranty applies only to purchases made in any province of Canada *except* for Yukon Territory, Nunavut, or Northwest Territories or in any of the 50 States of the USA (and the District of Columbia) *except* for Hawaii and Alaska. This limited warranty applies to the original purchaser of the product only and is not transferable.

Products excluded from this limited warranty

Light bulbs are not covered by this limited warranty and are the sole responsibility of the owner/purchaser. Products purchased in Yukon Territory, Nunavut,

Northwest Territories, Hawaii, or Alaska are not covered by this limited warranty. Products purchased in these States, provinces, or territories are sold AS IS without warranty or condition of any kind (including, without limitation, any implied warranties or conditions of merchantability or fitness for a particular purpose) and the entire risk of as to the quality and performance of the products is with the purchaser, and in the event of a defect the purchaser assumes the entire cost of all necessary servicing or repair.

What this limited warranty covers and for how long

Products covered by this limited warranty have been tested and inspected prior to shipment and, subject to the provisions of this warranty, Dimplex warrants such products to be free from defects in material and workmanship for a period of 12 months from the date of the first purchase of such product.



Warranty

The limited 12 month warranty period also applies to any implied warranties that may exist under applicable law. Some jurisdictions do not allow limitations on how long an implied warranty lasts, so the above limitation may not apply to the purchaser.

What this limited warranty does not cover

This limited warranty does not apply to products that have been repaired (except by Dimplex or its authorized service representatives) or otherwise altered. This limited warranty does further not apply to defects resulting from misuse, abuse, accident, neglect, incorrect installation, improper maintenance or handling, or operation with an incorrect power source.

What you must do to get service under this limited warranty

Defects must be brought to the attention of Dimplex Technical Service by contacting Dimplex at 1-888-DIMPLEX (1-888-346-7539), or 1367 Industrial Road, Cambridge Ontario, Canada N3H 4W3. Please have proof of purchase, catalogue/model and serial numbers available when calling. Limited warranty service requires a proof of purchase of the product.

What Dimplex will do in the event of a defect

In the event a product or part covered by this limited warranty is proven to be defective in material or workmanship during the 12 month limited warranty period you have the following rights:

- Dimplex will in its sole discretion either repair or replace such defective product or part without charge. If Dimplex is unable to repair or replace such product or part, or if repair or replacement is not commercially practicable or cannot be timely made, Dimplex may, in lieu of repair or replacement, choose to refund the purchase price for such product or part.

- Limited warranty service will be performed solely by dealers or service agents of Dimplex authorized to provide limited warranty services.
- The purchaser is responsible for removal and transportation of such product or part (and any repaired or replacement product or part) to and from the authorized dealer's or service agent's place of business.
- This limited warranty does not entitle the purchaser to on-site or in-home services. On-site or in-home services may be performed at the purchaser's specific request and expense at Dimplex's then-current rates for such services.
- Dimplex will not be responsible for, and the limited warranty services shall not include, any expense incurred for installation or removal of the product or part (or any replacement product or part) or any labour or transportation costs. Such costs shall be the purchaser's responsibility.

What Dimplex and its dealers and service agents are also not responsible for:

IN NO EVENT WILL DIMPLEX, OR ITS DIRECTORS, OFFICERS, OR AGENTS, BE LIABLE TO THE PURCHASER OR ANY THIRD PARTY, WHETHER IN CONTRACT, IN TORT, OR ON ANY OTHER BASIS, FOR ANY INDIRECT, SPECIAL, PUNITIVE, EXEMPLARY, CONSEQUENTIAL, OR INCIDENTAL LOSS, COST, OR DAMAGE ARISING OUT OF OR IN CONNECTION WITH THE SALE, MAINTENANCE, USE, OR INABILITY TO USE THE PRODUCT, EVEN IF DIMPLEX OR ITS DIRECTORS, OFFICERS, OR AGENTS HAVE BEEN ADVISED OF THE POSSIBILITY OF SUCH LOSSES, COSTS OR DAMAGES, OR IF SUCH LOSSES, COSTS, OR DAMAGES ARE



Warranty

FORESEEABLE. IN NO EVENT WILL DIMPLEX, OR ITS OFFICERS, DIRECTORS, OR AGENTS BE LIABLE FOR ANY DIRECT LOSSES, COSTS, OR DAMAGES THAT EXCEED THE PURCHASE PRICE OF THE PRODUCT.

SOME JURISDICTIONS DO NOT ALLOW THE EXCLUSION OR LIMITATION OF INCIDENTAL OR CONSEQUENTIAL DAMAGES, SO THE ABOVE LIMITATION OR EXCLUSION MAY NOT APPLY TO THE PURCHASER.

How State and Provincial law apply

This limited warranty gives you specific legal rights, and you may also have other rights which vary from jurisdiction to jurisdiction. The provisions of the United Nations Convention on Contracts for the Sale of Goods shall not apply to this limited warranty or the sale of products covered by this limited warranty.



Technical Support

Technical and troubleshooting support, as well as a list of replacement parts can be found on

www.dimplex.com/customer_support.



Dimplex North America Limited

1367 Industrial Road
Cambridge ON
Canada N3H 4W3

© 2013 Dimplex North America Limited